

CATALOGO  
2024



TARIFA DE PVP ACTUALIZADA





**KROMER**

DISTRIBUIDORA DE PRODUCTOS SANITARIOS

# CON LA ILUSIÓN DEL PRIMER DÍA



# PRODUCTOS Y SOLUCIONES



**KROMER**

DISTRIBUIDORA DE PRODUCTOS SANITARIOS



# KROMER es Calidad y diseño.



Las nuevas colecciones de griferías Kromer te descubrirán efectos de diseño y sensaciones inesperadas.

Nuestra siempre alta Calidad junto con un Diseño cuidado y precios competitivos siguen marcando nuestra identidad..

## Cuidamos hasta el último detalle.



Kromer asume un compromiso contigo que va desde el inicio hasta la finalización del proyecto. Nos preocupamos porque sabemos que cada detalle cuenta.

## Selección de los mejores componentes.



Nuestro equipo cuida y selecciona minuciosamente cada componente que forma a su vez cada serie.

Y es que la experiencia está de nuestro lado tras tantos años a la cabeza del sector.

## Puntualidad.

Todo lo anteriormente citado culmina con un plazo de entrega riguroso y exhaustivo.

Un plazo de entre 48 y 72h.



## En el tiempo.

El compromiso de Kromer con usted no termina. Seguimiento, asistencia, asesoramiento o garantía, infórmese acerca de todas las ventajas que ponemos a su disposición para su mayor tranquilidad.

\* Hay zonas de entrega especiales como Ceuta o Islas Canarias, en caso de duda, consultar.



# ÍNDICE / GUÍA RÁPIDA

## SERIES COMPLETAS



**KALUS**  
p.8



**KANIA**  
p.12



**KELENA**  
p.16



**KIRIA**  
p.20



**KIRIA PLUS**  
p.26



**KARES**  
p.32



**KITIANA**  
p.36



**KUBER**  
p.40



**KASTILA CR**  
p.46



**KASTILA LV**  
p.48

## TERMOSTÁTICAS



**KARLA DUCHA**  
p.52



**KARLA BAÑO**  
p.52



**KIRIA**  
p.52



**KIRIA DUAL**  
p.52



**KUBER**  
p.53



**KUBER DUAL**  
p.53

## CONJU. Y ACC. DUCHA



**BARRAS Y KITS SUELTOS**  
p.57



**MONOMANDOS PARA KIT**  
p.58



**ROCIADORES**  
p.60



**BRAZOS**  
p.61



**MANGOS**  
p.63



**SOPORTES**  
p.64



**FLEXOS**  
p.65

## SERIE COCINA



**INOXIDABLES**  
p.68



**ABATIBLES**  
p.69



**OSMOSIS**  
p.69



**EXTRAIBLES**  
p.70



**BLANCO/NEGRO**  
p.72



**GAMA ALTA**  
p.73



**ÉPOCA**  
p.75



**BÁSICOS**  
p.76



**MURALES**  
p.77



**CUBETAS**  
p.82

# ÍNDICE / GUÍA RÁPIDA

## LAVABOS



**BOL**  
p.88

## GRIFERÍA TÉCNICA



**TEMPORIZADOS**  
p.92



**PEDALES**  
p.93



**ELECTRONICOS**  
p.94



**MEDICALES**  
p.95

## COLECTIVIDADES



**DISPENSADORES  
JABÓN**  
p.100



**DISPENSADORES  
PAPEL**  
p.100



**SECAMANOS**  
p.101

## AYUDAS TÉCNICAS



**BARRAS  
ABATIBLES**  
p.104



**BARRAS  
FIJAS**  
p.105



**ASIENTOS**  
p.105

## SERIE HOTEL



**ACCESORIOS**  
p.108

## REPUESTOS



**CARTUCHOS**  
p.111



**MANETAS**  
p.113



**MANGOS  
Y FLEXOS**  
p.115



**FIJACION**  
p.115



**SIFONES Y  
VALVULAS**  
p.116



KROMER



# KALUS

La colección de grifería KALUS ha sido diseñada con líneas básicas y suaves sin renunciar a aspectos técnicos y funcionales.

Con una cuidada selección de materiales y componentes, la grifería KALUS ha sido extensamente probada con resultados óptimos de calidad y funcionalidad, siendo por tanto fiable.



Maneta personalizada para cada serie.

Cartucho cerámico certificado.

Aireador homologado.

Cuerpo de latón cromado.

Base de plástico.



## SISTEMA DE AHORRO DE AGUA



*Todas nuestras griferías disponen de aireadores que reducen hasta un 50% el consumo de agua.*



## KALUS LAVABO

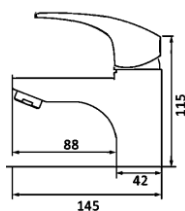

Monomando de lavabo. Cartucho cerámico de 40 mm. Apertura suave. Conexiones flexibles certificadas 40 cm. *Single lever basin mixer. 40 mm ceramic cartridge. Smooth opening. 40 cm certified flexible.*

REF.	€	Caja
102001004	-	10

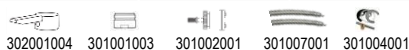

## KALUS BIDÉ

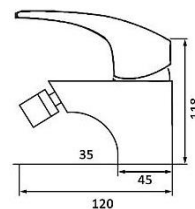

Monomando de bidé. Cartucho cerámico de 40 mm. Apertura suave. Conexiones flexibles certificadas 40 cm. *Single lever basin mixer. 40 mm ceramic cartridge. Smooth opening. 40 cm certified flexible.*

REF.	€	Caja
102001002	-	10



## KALUS DUCHA

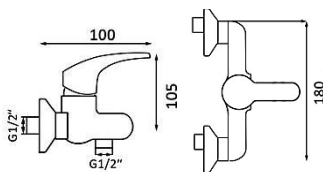

Monomando de ducha. Cartucho cerámico de 40 mm. Apertura suave. Flexo, mango y soporte. *Single lever shower mixer. 40 mm ceramic cartridge. Smooth opening. Hose, handle and support.*

REF.	€	Caja
102001003	-	10



## KALUS BAÑO

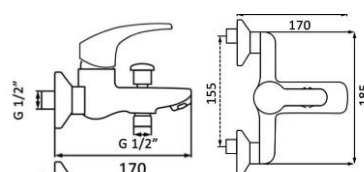

Monomando de baño. Cartucho cerámico de 40 mm. Apertura suave. Flexo, mango y soporte. *Single lever bath shower mixer. 40 mm ceramic cartridge. Smooth opening. Hose, handle and support.*

REF.	€	Caja
102001001	-	10



## KALUS DUCHA EMPOTRAR

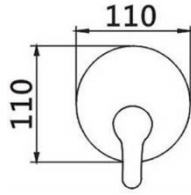

Monomando de ducha de empotrar. Cartucho cerámico de 40 mm. Apertura suave.

*Built in single lever shower mixer. 40 mm ceramic cartridge. Smooth opening.*

REF.	€	Caja
102001005	-	6



## KALUS KIT DUCHA EMPOTRAR

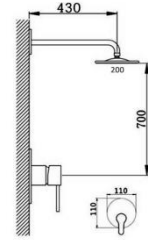

Kit monomando de ducha de empotrar. Cartucho cerámico de 40 mm. Apertura suave. Brazo y rociador de 20 cm.

*Kit Built in single lever shower mixer. 40 mm ceramic cartridge. Smooth opening. Shower arm and 20 cm shower head.*

REF.	€	Caja
102001006	-	1

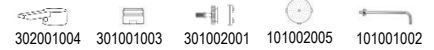

## KALUS KIT DUCHA

**NUEVO PRODUCTO**

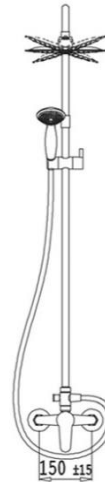
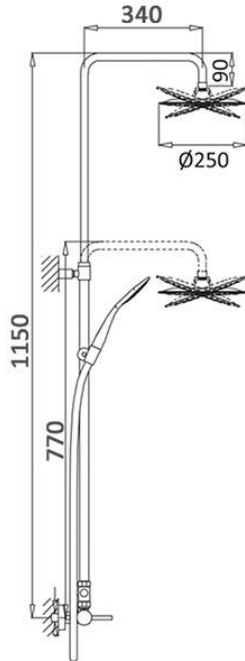

Conjunto kit ducha. Cartucho de 35 mm. Apertura suave. Rociador inox. 25 cm. Barra telescópica. Flexo 1,7 m. Mango 3 posiciones.

*Shower system for wall mounting with adjustable. Smooth opening. 25 cm Inox shower head. Telescopic bar. 1,7 m hose. 3 position shower hand.*

REF.	€	Caja
102001007	-	6





KROMER



# KANIA

La colección de grifería KANIA ha sido diseñada con líneas elegantes y sencillas.

Con una cuidada selección de materiales y componentes, la grifería KANIA ha sido extensamente probada con resultados óptimos de calidad y funcionalidad, siendo por tanto fiable, llevando esta serie un paso por encima de la grifería convencional económica.



Maneta personalizada para cada serie.

Cartucho cerámico certificado.

Cuerpo de latón cromado.

Aireador homologado.

Base de plástico.



## SISTEMA DE AHORRO DE AGUA



*Todas nuestras griferías disponen de aireadores que reducen hasta un 50% el consumo de agua.*



## KANIA LAVABO

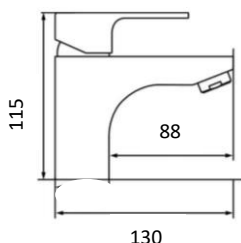

Monomando de lavabo. Cartucho cerámico de 35 mm. Apertura suave. Conexiones flexibles certificadas 40 cm. Single lever basin mixer. 35 mm ceramic cartridge. Smooth opening. 40 cm certified flexible.

REF.	€	Caja
102002004	-	10



## KANIA LAVABO PLUS

**PROXIMAMENTE**

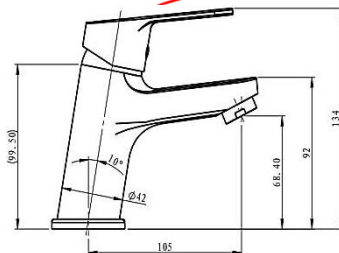

Monomando de lavabo. Cartucho cerámico de 35 mm. Apertura suave. Conexiones flexibles certificadas 40 cm. Single lever basin mixer. 35 mm ceramic cartridge. Smooth opening. 40 cm certified flexible.

REF.	€	Caja
102002006	-	10



## KANIA BIDÉ

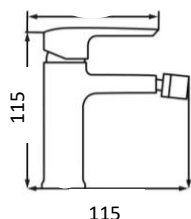

Monomando de bidé. Cartucho cerámico de 35 mm. Apertura suave. Conexiones flexibles certificadas 40 cm. Single lever basin mixer. 35 mm ceramic cartridge. Smooth opening. 40 cm certified flexible.

REF.	€	Caja
102002002	-	10



## KANIA DUCHA

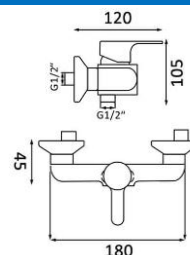

Monomando de ducha. Cartucho cerámico de 35 mm. Apertura suave. Flexo, mango y soporte. Single lever shower mixer. 35 mm ceramic cartridge. Smooth opening. Hose, handle and support.

REF.	€	Caja
102002003	-	10



## KANIA BAÑO

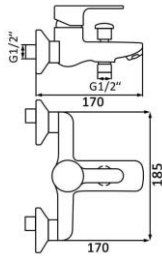

Monomando de baño. Cartucho cerámico de 35 mm.  
Apertura suave. Flexo, mango y soporte.  
Single lever bath shower mixer. 35 mm ceramic cartridge.  
Smooth opening. Hose, handle and support.

REF.	€	Caja
102002001	-	6



## KANIA KIT DUCHA

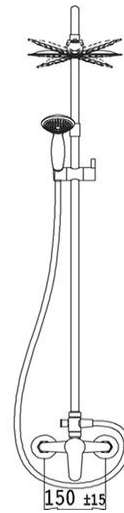
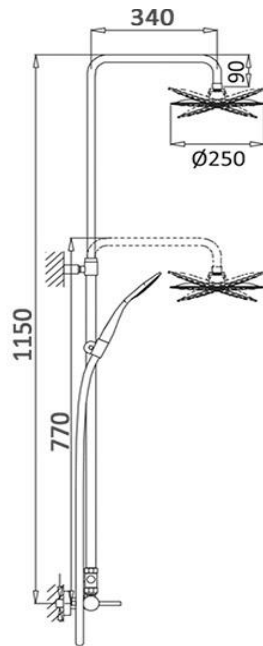

Conjunto kit ducha. Cartucho de 35 mm. Apertura suave.  
Rociador inox. 25 cm. Barra telescópica. Flexo 1,7 m.  
Mango 3 posiciones.

Shower system for wall mounting with adjustable. Smooth opening. 25 cm Inox shower head. Telescopic bar. 1,7 m hose. 3 position shower hand.

REF.	€	Caja
101007001	-	6







# KELENA

La colección de grifería KELENA ha sido diseñada con líneas robustas y elegantes con un gran cuerpo.

Con una cuidada selección de materiales y componentes, la grifería KELENA ha sido extensamente probada con resultados óptimos de calidad y funcionalidad, siendo por tanto fiable, llevando esta serie un nivel medio -alto.



Maneta personalizada para cada serie.

Cartucho cerámico certificado.

Aireador homologado.

Cuerpo de latón cromado.

Base de plástico.

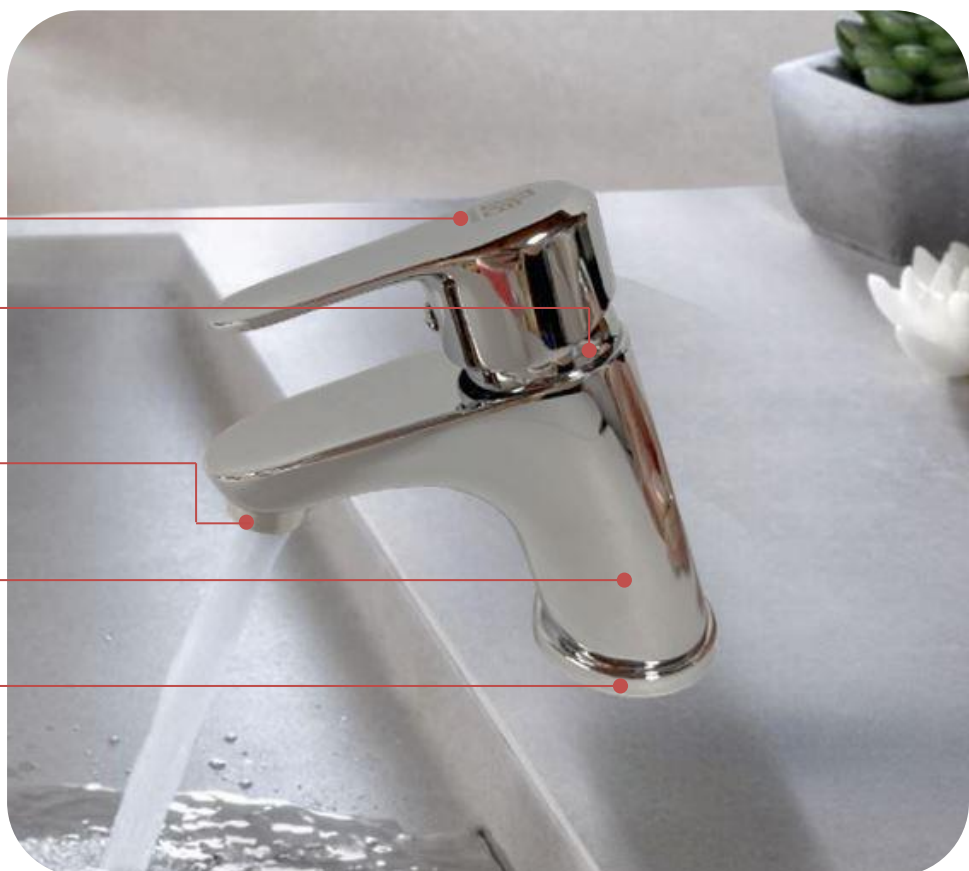

## SISTEMA DE AHORRO DE AGUA



*Todas nuestras griferías disponen de aireadores que reducen hasta un 50% el consumo de agua.*



## KELENA LAVABO

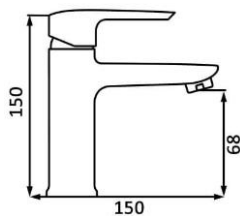

Monomando de lavabo. Cartucho cerámico de 35 mm. Apertura suave. Conexiones flexibles certificadas 40 cm. *Single lever basin mixer. 35 mm ceramic cartridge. Smooth opening. 40 cm certified flexible.*

REF.	€	Caja
102006004	-	10

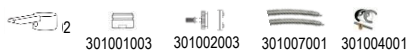

## KELENA BIDÉ

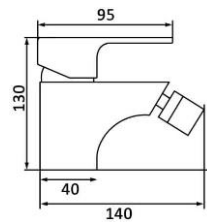

Monomando de bidé. Cartucho cerámico de 35 mm. Apertura suave. Conexiones flexibles certificadas 40 cm. *Single lever basin mixer. 35 mm ceramic cartridge. Smooth opening. 40 cm certified flexible.*

REF.	€	Caja
102006002	-	10

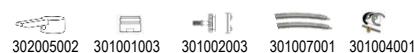

## KELENA DUCHA

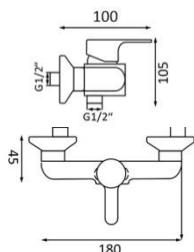

Monomando de ducha. Cartucho cerámico de 35 mm. Apertura suave. Flexo, mango y soporte. *Single lever shower mixer. 35 mm ceramic cartridge. Smooth opening. Hose, handle and support.*

REF.	€	Caja
102006003	-	10



## KELENA BAÑO

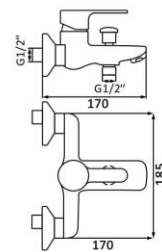

Monomando de baño. Cartucho cerámico de 35 mm. Apertura suave. Flexo, mango y soporte. *Single lever bath shower mixer. 35 mm ceramic cartridge. Smooth opening. Hose, handle and support.*

REF.	€	Caja
102006001	-	10



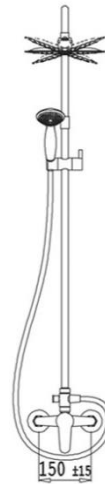
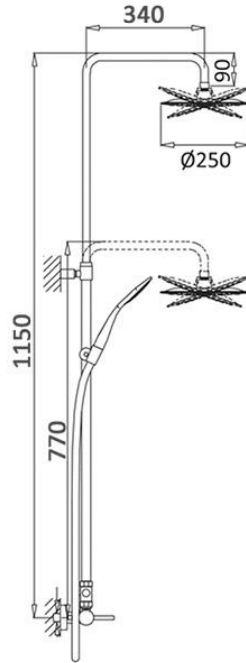

Conjunto kit ducha. Cartucho de 35 mm. Apertura suave. Rociador inox. 25 cm. Barra telescópica. Flexo 1,7 m. Mango 3 posiciones.  
 Shower system for wall mounting with adjustable. Smooth opening. 25 cm Inox shower head. Telescopic bar. 1,7 m hose. 3 position shower hand.

REF.	€	Caja
101006007	-	6

-  302005002
-  301002003
-  302001002
-  302008003
-  301005003
-  301006002
-  101002005



KROMER



# KIRIA

La colección de grifería KIRIA ha sido diseñada con líneas finas y delgadas con un cuerpo alto.

Con una cuidada selección de materiales y componentes, la grifería KIRIA ha sido extensamente probada con resultados óptimos de calidad y funcionalidad, siendo por tanto fiable, llevando esta serie un nivel medio - alto.



Maneta personalizada para cada serie.

Cartucho cerámico certificado.

Aireador homologado.

Cuerpo de latón cromado.

Base de plástico.



## SISTEMA DE AHORRO DE AGUA



*Todas nuestras griferías disponen de aireadores que reducen hasta un 50% el consumo de agua.*



## KIRIA LAVABO

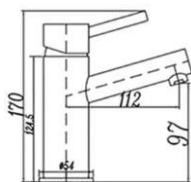

Monomando de lavabo. Cartucho cerámico de 35 mm. Apertura suave. Conexiones flexibles certificadas 40 cm. Single lever basin mixer. 35 mm ceramic cartridge. Smooth opening. 40 cm certified flexible.

REF.	€	Caja
102007004	-	12



## KIRIA LAVABO ALTO

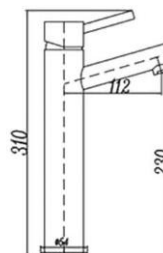

Monomando de lavabo alto. Cartucho cerámico de 35 mm. Apertura suave. Conexiones flexibles certificadas 40 cm. Single lever basin mixer. 35 mm ceramic cartridge. Smooth opening. 40 cm certified flexible.

REF.	€	Caja
102007007	-	12



## KIRIA LAVABO EMPOTRAR

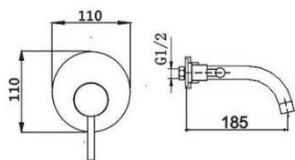

Monomando de lavabo empotrable. Cartucho cerámico de 35 mm. Apertura suave. Built-in single lever basin mixer. 35 mm ceramic cartridge. Smooth opening.

REF.	€	Caja
102007010	-	12



## KIRIA BIDÉ

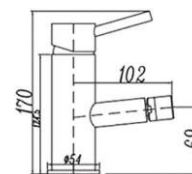

Monomando de bidé. Cartucho cerámico de 35 mm. Apertura suave. Conexiones flexibles certificadas 40 cm. Single lever bidet mixer. 35 mm ceramic cartridge. Smooth opening. 40 cm certified flexible.

REF.	€	Caja
102007002	-	12

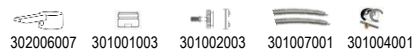

## KIRIA BAÑO

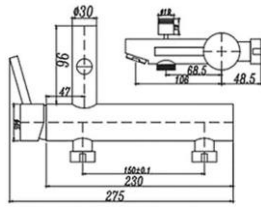

Monomando de baño. Cartucho cerámico de 35 mm. Apertura suave. Flexo, mango y soporte.

Single lever bath mixer. 35 mm ceramic cartridge. Smooth opening. Hose, handle and support.

REF.	€	Caja
102007001	-	6



## KIRIA DUCHA

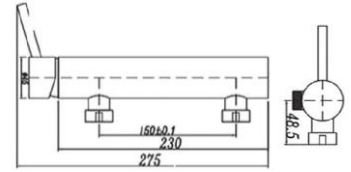

Monomando de ducha. Cartucho cerámico de 35 mm. Apertura suave. Flexo, mango y soporte.

Single lever bath mixer. 35 mm ceramic cartridge. Smooth opening. Hose, handle and support.

REF.	€	Caja
102007003	-	6



## KIRIA DUCHA EMPOTRAR

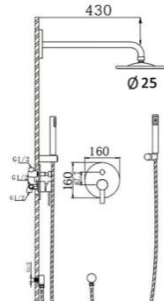

Monomando de ducha empotrable. Cartucho cerámico de 35 mm. Apertura suave. Flexo, mango y soporte.

Built-in single lever basin mixer. 35 mm ceramic cartridge. Smooth opening.

REF.	€	Caja
102007005	-	1



## KIRIA KIT HIGIENICO EMPOTRAR

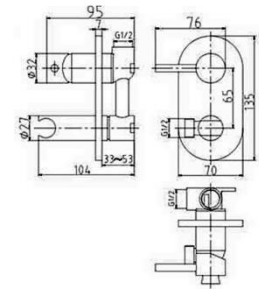

Monomando higiénico. Cartucho cerámico de 25 mm. Apertura suave. Incluye flexo y mango.

Concealed single lever mixer bidet toilets. 25 mm ceramic cartridge. Smooth opening. Hose and handle.

REF.	€	Caja
102007006	-	20

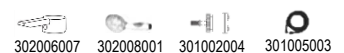

# KIRIA KIT DUCHA



**Conjunto kit ducha. Cartucho de 35 mm. Apertura suave. Rociador inox. 25 cm. Barra telescópica. Flexo 1,7 m. Mango 3 posiciones.**

*Shower system for wall mounting with adjustable. Smooth opening. 25 cm Inox shower head. Telescopic bar. 1,7 m hose. 3 position shower hand.*

REF.	€	Caja
101006001	-	5



# KIRIA KIT DUCHA TERMOSTATICA

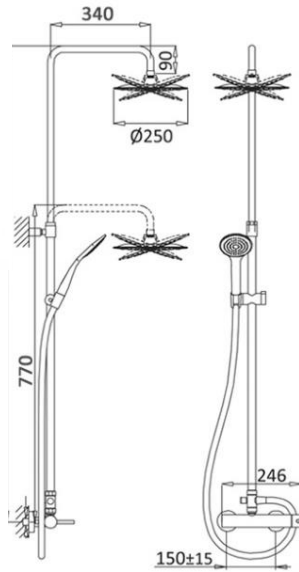

**Conjunto kit ducha. Cartucho termostático. Apertura suave. Rociador inox. 25 cm. Barra telescópica. Flexo 1,7 m. Mango 3 posiciones.**

*Thermostatic Shower system for wall mounting with adjustable. Smooth opening. 25 cm Inox shower head. Telescopic bar. 1,7 m hose. 3 position shower hand.*

REF.	€	Caja
101006002	-	5







# KIRIA PLUS

La colección de grifería KIRIA PLUS ha sido diseñada con líneas finas y delgadas con un cuerpo alto diferenciándose del resto por su maneta en color negro.

Con una cuidada selección de materiales y componentes, la grifería KIRIA ha sido extensamente probada con resultados óptimos de calidad y funcionalidad, siendo por tanto fiable, llevando esta serie un nivel medio - alto.



Maneta personalizada para cada serie.

Cartucho cerámico certificado.

Aireador homologado.

Cuerpo de latón cromado.

Base de plástico.



## SISTEMA DE AHORRO DE AGUA



*Todas nuestras griferías disponen de aireadores que reducen hasta un 50% el consumo de agua.*



## KIRIA PLUS LAVABO

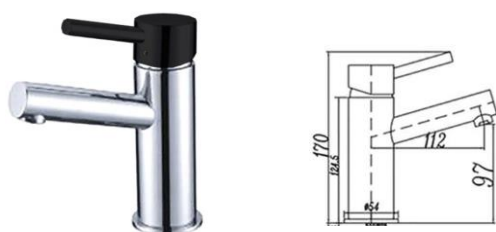

Monomando de lavabo. Cartucho cerámico de 35 mm. Apertura suave. Conexiones flexibles certificadas 40 cm. Single lever basin mixer. 35 mm ceramic cartridge. Smooth opening. 40 cm certified flexible.

REF.	€	Caja
102011004	-	12



## KIRIA PLUS LAVABO ALTO

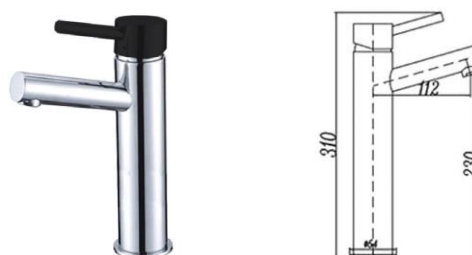

Monomando de lavabo alto. Cartucho cerámico de 35 mm. Apertura suave. Conexiones flexibles certificadas 40 cm. Single lever basin mixer. 35 mm ceramic cartridge. Smooth opening. 40 cm certified flexible.

REF.	€	Caja
102011007	-	12



## KIRIA PLUS LAVABO EMPOTRAR

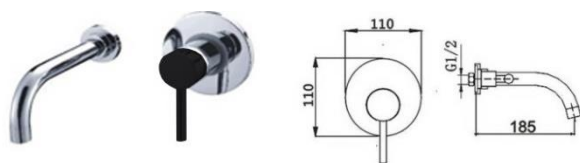

Monomando de lavabo empotrable. Cartucho cerámico de 35 mm. Apertura suave. Built-in single lever basin mixer. 35 mm ceramic cartridge. Smooth opening.

REF.	€	Caja
102011008	-	12



## KIRIA PLUS LAVABO EMPOTRAR



Monomando de lavabo empotrable. Cartucho cerámico de 35 mm. Apertura suave. Built-in single lever basin mixer. 35 mm ceramic cartridge. Smooth opening.

REF.	€	Caja
102011009	-	12



## KIRIA PLUS BIDE

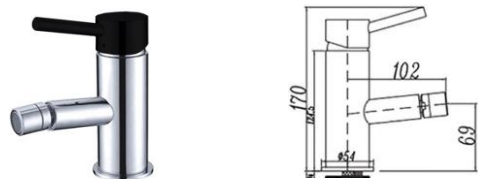

Monomando de bidé. Cartucho cerámico de 35 mm. Apertura suave. Conexiones flexibles certificadas 40 cm. Single lever bidet mixer. 35 mm ceramic cartridge. Smooth opening. 40 cm certified flexible.

REF.	€	Caja
102011002	-	12

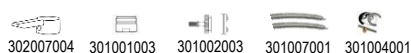

## KIRIA DUCHA

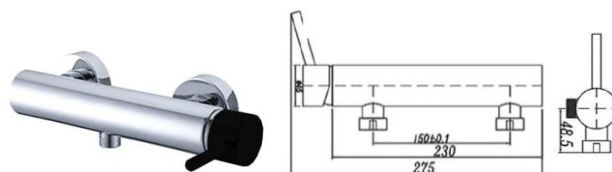

Monomando de ducha. Cartucho cerámico de 35 mm. Apertura suave. Flexo, mango y soporte. Single lever bath mixer. 35 mm ceramic cartridge. Smooth opening. Hose, handle and support.

REF.	€	Caja
102011003	-	6



## KIRIA PLUS DUCHA EMPOTRAR



Monomando de ducha empotrable. Cartucho cerámico de 35 mm. Apertura suave. Flexo, mango y soporte. Built-in single lever basin mixer. 35 mm ceramic cartridge. Smooth opening.

REF.	€	Caja
102011005	-	1



## KIRIA PLUS BAÑO

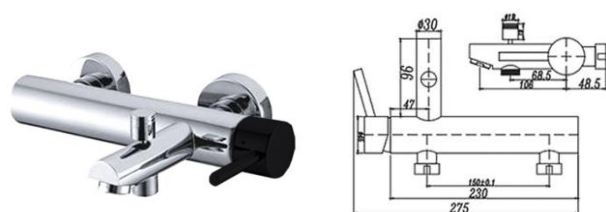

Monomando de baño. Cartucho cerámico de 35 mm. Apertura suave. Flexo, mango y soporte. Single lever bath mixer. 35 mm ceramic cartridge. Smooth opening. Hose, handle and support.

REF.	€	Caja
102011001	-	6





# KIRIA KIT HIGIENICO EMPOTRAR

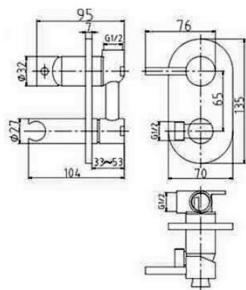

**Monomando higiénico. Cartucho cerámico de 25 mm. Apertura suave. Incluye flexo y mango.**

*Concealed single lever mixer bidet toilets. 25 mm ceramic cartridge. Smooth opening. Hose and handle.*

REF.	€	Caja
102011006	-	20

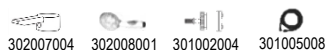



# KIRIA PLUS KIT DUCHA

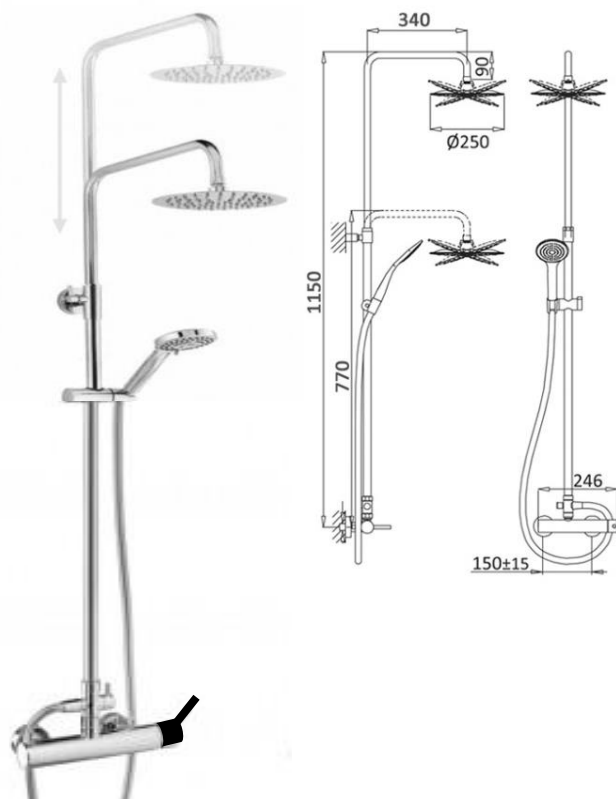

**Conjunto kit ducha. Cartucho de 35 mm. Apertura suave. Rociador inox. 25 cm. Barra telescópica. Flexo 1,7 m. Mango 3 posiciones.**

*Shower system for wall mounting with adjustable. Smooth opening. 25 cm Inox shower head. Telescopic bar. 1,7 m hose. 3 position shower hand.*

REF.	€	Caja
101006006	-	6





  
KROMER

<sup>®</sup>  
KROMER

# KARES

La colección de grifería KARES ha sido diseñada con líneas rectas y redondeadas con un cuerpo medio y con su imitación efecto cascada hacen de esta serie puro diseño.

Con una cuidada selección de materiales y componentes, la grifería KARES ha sido extensamente probada con resultados óptimos de calidad y funcionalidad, siendo por tanto fiable, llevando esta serie un nivel alto.



Maneta personalizada para cada serie.

Cartucho cerámico certificado.

Aireador homologado.

Cuerpo de latón cromado.

Base de plástico.



## SISTEMA DE AHORRO DE AGUA



*Todas nuestras griferías disponen de aireadores que reducen hasta un 50% el consumo de agua.*



## KARES LAVABO

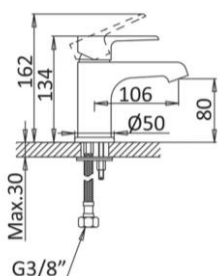

Monomando de lavabo. Cartucho cerámico de 35 mm. Apertura suave. Conexiones flexibles certificadas 40 cm. Single lever basin mixer. 35 mm ceramic cartridge. Smooth opening. 40 cm certified flexible.

REF.	€	Caja
102003004	-	10

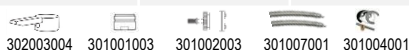

## KARES LAVABO ALTO

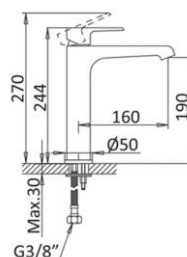

Monomando de lavabo alto. Cartucho cerámico de 35 mm. Apertura suave. Conexiones flexibles certificadas 40 cm. Single lever basin mixer. 35 mm ceramic cartridge. Smooth opening. 40 cm certified flexible.

REF.	€	Caja
102003007	-	10



## KARES BIDE

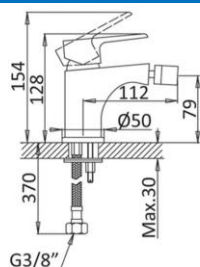

Monomando de bidé. Cartucho cerámico de 35 mm. Apertura suave. Conexiones flexibles certificadas 40 cm. Single lever bidet mixer. 35 mm ceramic cartridge. Smooth opening. 40 cm certified flexible.

REF.	€	Caja
102003002	-	12



## KARES DUCHA

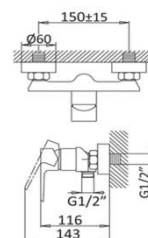

Monomando de ducha. Cartucho cerámico de 35 mm. Apertura suave. Flexo, mango y soporte. Single lever bath mixer. 35 mm ceramic cartridge. Smooth opening. Hose, handle and support.

REF.	€	Caja
102003003	-	12



## KARES BAÑO

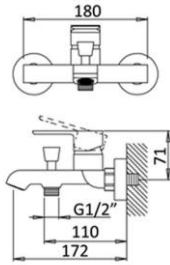

Monomando de baño. Cartucho cerámico de 35 mm. Apertura suave. Flexo, mango y soporte.  
Single lever bath mixer. 35 mm ceramic cartridge. Smooth opening. Hose, handle and support.

REF.	€	Caja
102003001	-	10



## KARES KIT HIGIENICO EMPOTRAR

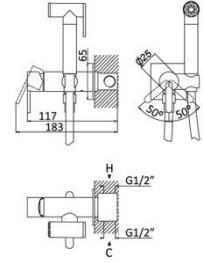

Monomando higiénico. Cartucho cerámico de 25 mm. Apertura suave. Incluye flexo y mango.  
Concealed single lever mixer bidet toilets. 25 mm ceramic cartridge. Smooth opening. Hose and handle.

REF.	€	Caja
102003006	-	10

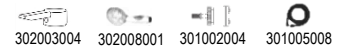

## KARES DUCHA EMPOTRAR

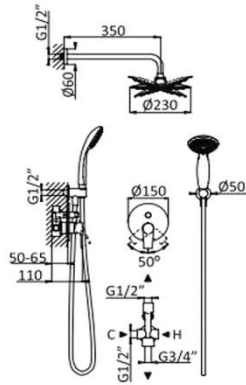

Monomando de ducha empotrable. Cartucho cerámico de 35 mm. Apertura suave. Flexo, mango y soporte.  
Built-in single lever basin mixer. 35 mm ceramic cartridge. Smooth opening.

REF.	€	Caja
102003005	-	10



## KARES KIT DUCHA

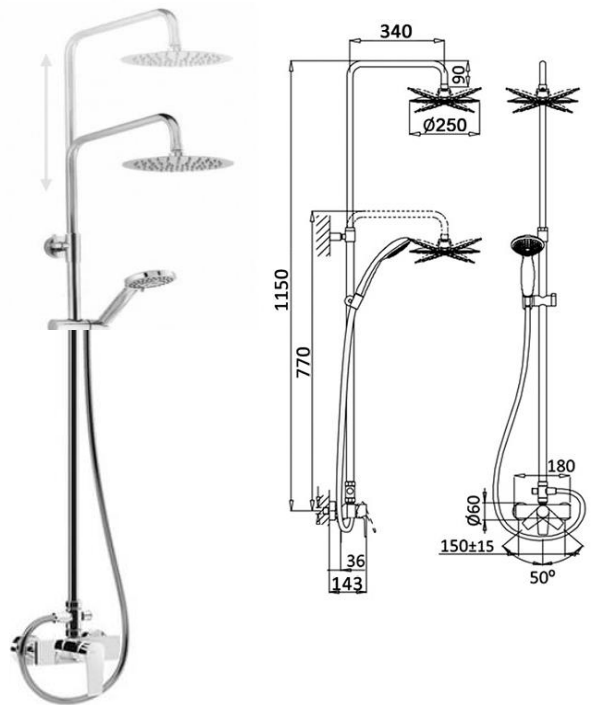

Conjunto kit ducha. Cartucho de 35 mm. Apertura suave. Rociador inox. 25 cm. Barra telescópica. Flexo 1,7 m. Mango 3 posiciones.  
Shower system for wall mounting with adjustable. Smooth opening. 25 cm Inox shower head. Telescopic bar. 1,7 m hose. 3 position shower hand.

REF.	€	Caja
101007002	-	6







# KITIANA

La colección de grifería KITIANA ha sido diseñada con líneas rectas y redondeadas con un cuerpo medio y con su acabado en negro mate hacen de esta serie pura elegancia y diseño.

Con una cuidada selección de materiales y componentes, la grifería KITIANA ha sido extensamente probada con resultados óptimos de calidad y funcionalidad, siendo por tanto fiable, llevando esta serie un nivel alto.



Maneta personalizada para cada serie.

Cartucho cerámico certificado.

Aireador homologado.

Cuerpo de latón cromado.

Base de plástico.



## SISTEMA DE AHORRO DE AGUA



*Todas nuestras griferías disponen de aireadores que reducen hasta un 50% el consumo de agua.*



## KITIANA LAVABO

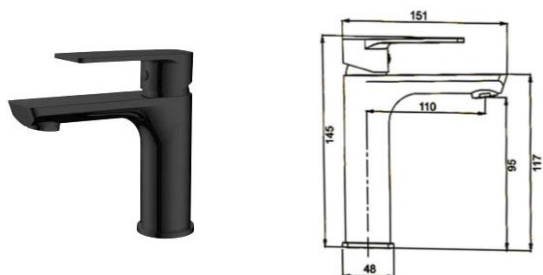

Monomando de lavabo. Cartucho cerámico de 35 mm. Apertura suave. Conexiones flexibles certificadas 40 cm. *Single lever basin mixer. 35 mm ceramic cartridge. Smooth opening. 40 cm certified flexible.*

REF.	€	Caja
102012004	-	10



## KITIANA LAVABO ALTO



Monomando de lavabo alto. Cartucho cerámico de 35 mm. Apertura suave. Conexiones flexibles certificadas 40 cm. *Single lever basin mixer. 35 mm ceramic cartridge. Smooth opening. 40 cm certified flexible.*

REF.	€	Caja
102012007	-	10



## KITIANA LAVABO EMPOTRAR

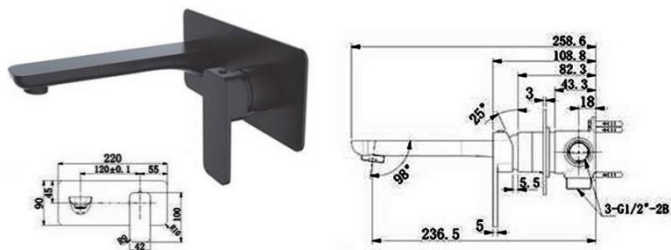

Monomando de lavabo empotrable. Cartucho cerámico de 35 mm. Apertura suave. *Built-in single lever basin mixer. 35 mm ceramic cartridge. Smooth opening.*

REF.	€	Caja
102012008	-	10



## KITIANA BIDE

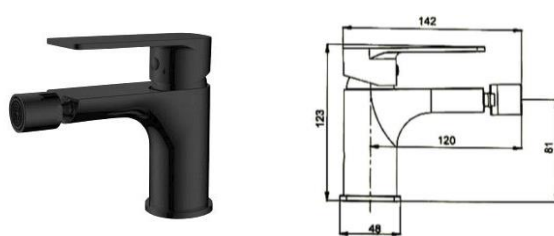

Monomando de bidé. Cartucho cerámico de 35 mm. Apertura suave. Conexiones flexibles certificadas 40 cm. *Single lever bidet mixer. 35 mm ceramic cartridge. Smooth opening. 40 cm certified flexible.*

REF.	€	Caja
102012002	-	10

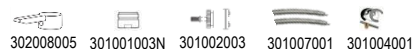

## KITIANA BAÑO

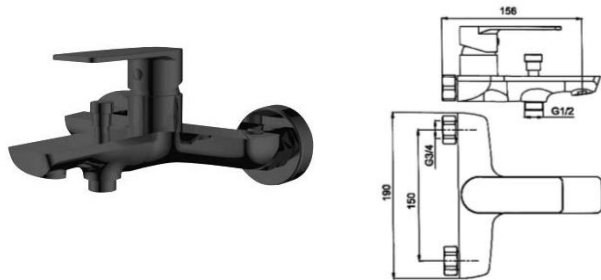

Monomando de baño. Cartucho cerámico de 35 mm. Apertura suave. Flexo, mango y soporte.  
Single lever bath mixer. 35 mm ceramic cartridge. Smooth opening. Hose, handle and support.

REF.	€	Caja
102012001	-	10



## KITIANA DUCHA

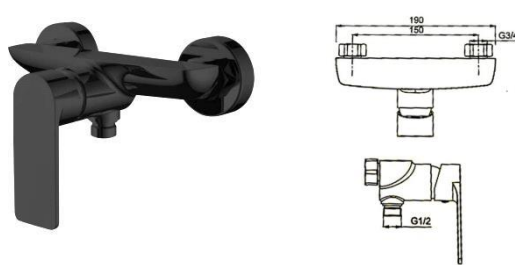

Monomando de ducha. Cartucho cerámico de 35 mm. Apertura suave. Flexo, mango y soporte.  
Single lever bath mixer. 35 mm ceramic cartridge. Smooth opening. Hose, handle and support.

REF.	€	Caja
102012003	-	10



## KITIANA DUCHA EMPOTRAR

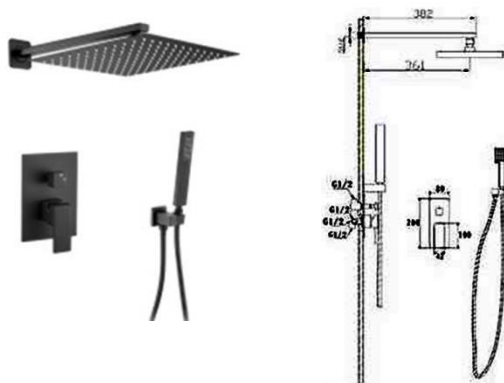

Monomando de ducha empotrable. Cartucho cerámico de 35 mm. Apertura suave. Flexo, mango y soporte.  
Built-in single lever basin mixer. 35 mm ceramic cartridge. Smooth opening.

REF.	€	Caja
102012009	-	10



## KITIANA KIT DUCHA

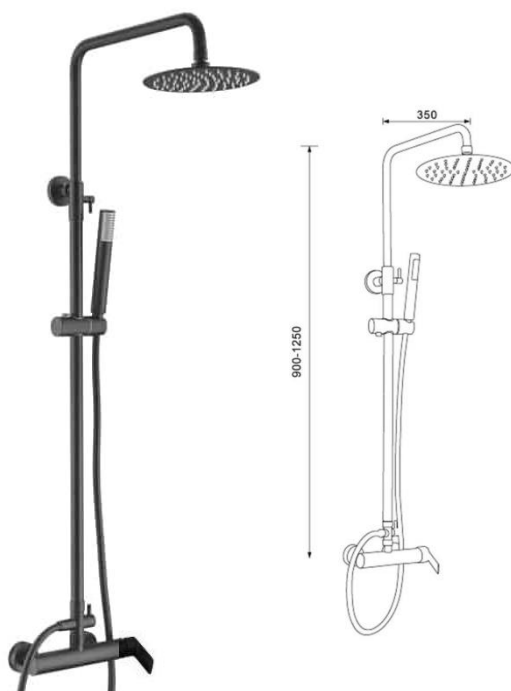

Conjunto kit ducha. Cartucho de 35 mm. Apertura suave. Rociador inox. 20 cm. Barra telescópica. Flexo 1,7 m. Mango 3 posiciones.

Shower system for wall mounting with adjustable. Smooth opening. 20 cm Inox shower head. Telescopic bar. 1,7 m hose. 3 position shower hand.

REF.	€	Caja
101007007	-	5





KROMER



# KUBER

La colección de grifería KUBER ha sido diseñada con líneas rectas con un gran cuerpo hacen de esta serie puro diseño.

Con una cuidada selección de materiales y componentes, la grifería KUBER ha sido extensamente probada con resultados óptimos de calidad y funcionalidad, siendo por tanto fiable, llevando esta serie un nivel alto.



Maneta personalizada para cada serie.

Cartucho cerámico certificado.

Aireador homologado.

Cuerpo de latón cromado.

Base de plástico.



## SISTEMA DE AHORRO DE AGUA



*Todas nuestras griferías disponen de aireadores que reducen hasta un 50% el consumo de agua.*



## KUBER LAVABO

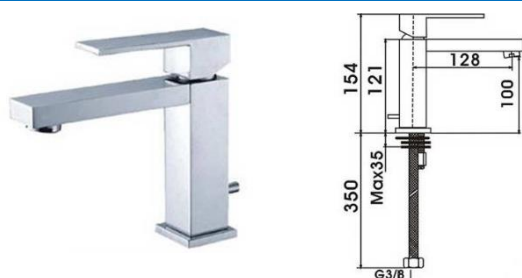

Monomando de lavabo. Cartucho cerámico de 35 mm. Apertura suave. Conexiones flexibles certificadas 40 cm. Single lever basin mixer. 35 mm ceramic cartridge. Smooth opening. 40 cm certified flexible.

REF.	€	Caja
102014004	-	10



## KUBER LAVABO ALTO



Monomando de lavabo alto. Cartucho cerámico de 35 mm. Apertura suave. Conexiones flexibles certificadas 40 cm. Single lever basin mixer. 35 mm ceramic cartridge. Smooth opening. 40 cm certified flexible.

REF.	€	Caja
102014006	-	10



## KUBER LAVABO EMPOTRAR

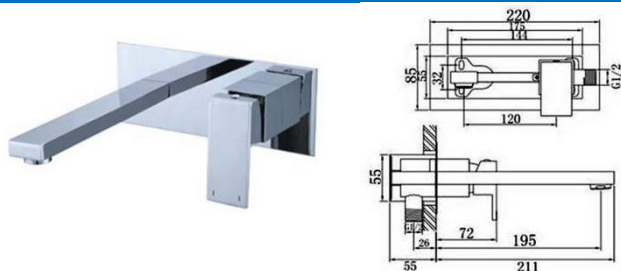

Monomando de lavabo empotrable. Cartucho cerámico de 35 mm. Apertura suave. Built-in single lever basin mixer. 35 mm ceramic cartridge. Smooth opening.

REF.	€	Caja
102014005	-	10



## KUBER BIDE



Monomando de bidé. Cartucho cerámico de 35 mm. Apertura suave. Conexiones flexibles certificadas 40 cm. Single lever bidet mixer. 35 mm ceramic cartridge. Smooth opening. 40 cm certified flexible.

REF.	€	Caja
102014002	-	10

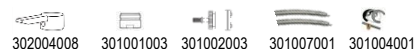

## KUBER BAÑO

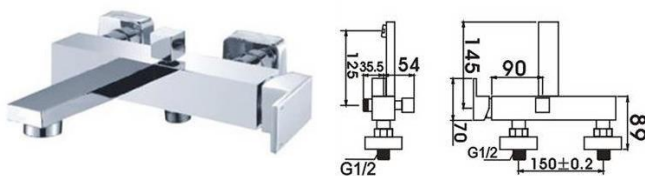

Monomando de baño. Cartucho cerámico de 35 mm. Apertura suave. Flexo, mango y soporte.

Single lever bath mixer. 35 mm ceramic cartridge. Smooth opening. Hose, handle and support.

REF.	€	Caja
102014001	-	10



## KUBER DUCHA

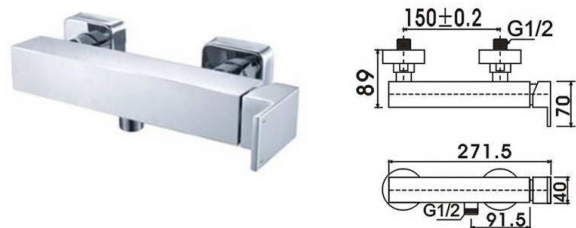

Monomando de ducha. Cartucho cerámico de 35 mm. Apertura suave. Flexo, mango y soporte.

Single lever bath mixer. 35 mm ceramic cartridge. Smooth opening. Hose, handle and support.

REF.	€	Caja
102014003	-	10



## KUBER KIT DUCHA

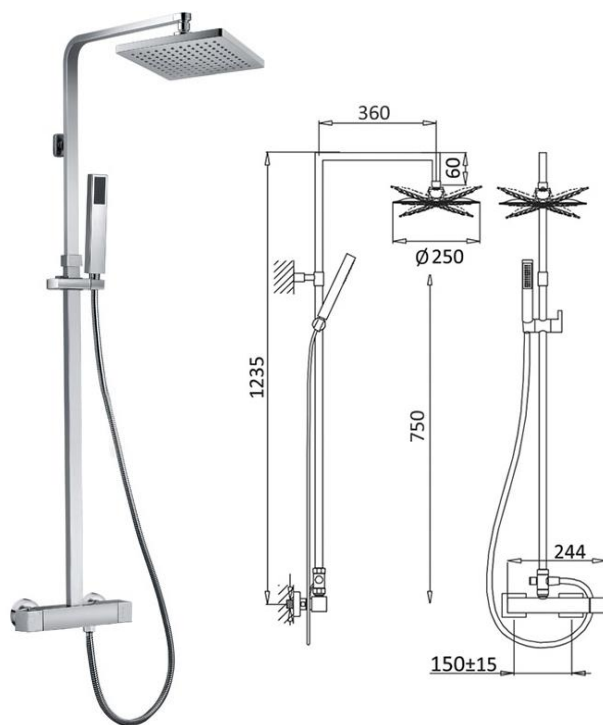

Conjunto kit ducha termostática. Apertura suave. Rociador inox. 25 cm. Barra telescópica. Flexo 1,7 m.

Thermostatic shower system for wall mounting with adjustable. Smooth opening. 25 cm Inox shower head. Telescopic bar. 1,7 m hose.

REF.	€	Caja
101003001	-	5







**KROMER**

# KASTILA CROMO

La colección de grifería KASTILA ha sido diseñada con un estilo clásico y rústico para transportarte a otra época.

Con una cuidada selección de materiales y componentes, la grifería KASTILA ha sido extensamente probada con resultados óptimos de calidad y funcionalidad, siendo por tanto fiable, llevando esta serie un nivel medio-alto.



Aireador homologado.

Maneta personalizada para cada serie.

Cuerpo de latón cromado.

Base de plástico.



## SISTEMA DE AHORRO DE AGUA



*Todas nuestras griferías disponen de aireadores que reducen hasta un 50% el consumo de agua.*





## KASTILA CR LAVABO

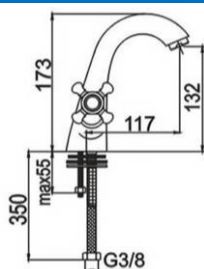

Monomando de lavabo. Montura cerámica de ¼ de vuelta. Conexiones flexibles certificadas 35 cm.

Single lever basin mixer. ¼ turning opening. 35 cm certified flexible.

REF.	€	Caja
102004004	-	10



## KASTILA CR BIDÉ

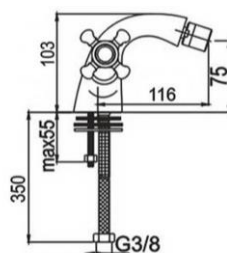

Monomando de bidé. Montura cerámica de ¼ de vuelta. Conexiones flexibles certificadas 35 cm.

Single lever bidet mixer. ¼ turning opening. 35 cm certified flexible.

REF.	€	Caja
102004002	-	10

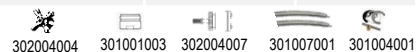

## KASTILA CR DUCHA

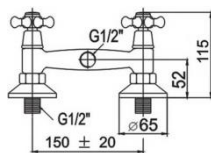

Monomando de ducha. Montura cerámica de ¼ de vuelta. Flexo, mango y soporte.

Ceramic headparts ¼ turning opening. Flexo hose, handle and support.

REF.	€	Caja
102004003	-	10



## KASTILA CR BAÑO

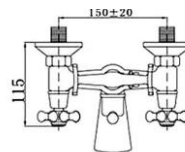
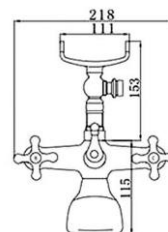

Monomando de baño. Montura cerámica de ¼ de vuelta. Flexo, mango y soporte.

Ceramic headparts ¼ turning opening. Flexo hose, handle and support.

REF.	€	Caja
102004001	-	10



## KASTILA CR FREGADERO

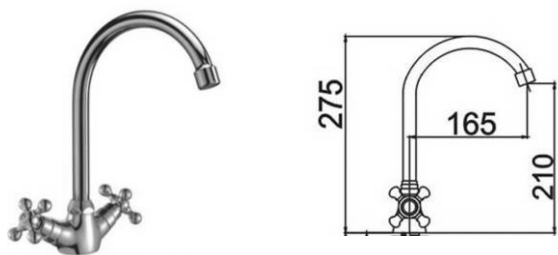

Monomando de fregadero monobloc. Montura cerámica 1/4 de vuelta. Caño giratorio. Conexiones flexibles certificadas 40 cm.

*Kitchen sink individual handle. 1/4 turn ceramic headparts. Swivel faucet. 40 cm certified flexible.*

REF.	€	Caja
203008002	-	12



## KASTILA CR FREGADERO RETRO

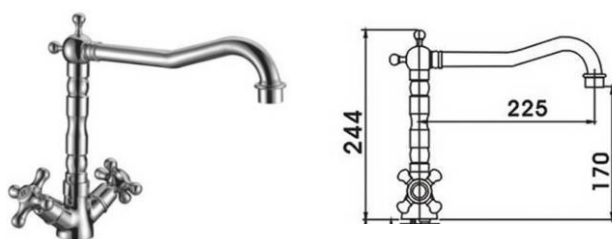

Monomando de fregadero monobloc. Montura cerámica 1/4 de vuelta. Caño giratorio. Conexiones flexibles certificadas 40 cm.

*Kitchen sink individual handle. 1/4 turn ceramic headparts. Swivel faucet. 40 cm certified flexible.*

REF.	€	Caja
203009002	-	8

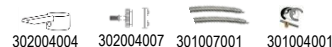

## KASTILA CR KIT DUCHA

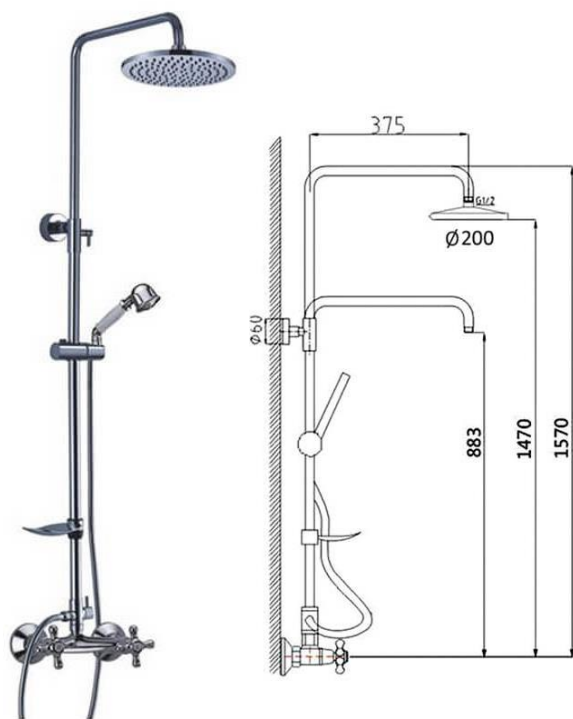

Conjunto kit ducha. Montura cerámica de 1/4 de vuelta. Rociador ABS 200 mm.

*Shower column with faucet. Ceramic headpart 1/4 turning opening. 200 mm ABS sprayer*

REF.	€	Caja
101004002	-	10





KROMER

# KASTILA LATÓN VIEJO

La colección de grifería KASTILA ha sido diseñada con un estilo clásico y rústico para transportarte a otra época.

Con una cuidada selección de materiales y componentes, la grifería KASTILA ha sido extensamente probada con resultados óptimos de calidad y funcionalidad, siendo por tanto fiable, llevando esta serie un nivel medio-alto.



Aireador homologado.

Maneta personalizada para cada serie.

Cuerpo de latón cromado.



## SISTEMA DE AHORRO DE AGUA



*Todas nuestras griferías disponen de aireadores que reducen hasta un 50% el consumo de agua.*





## KASTILA LV LAVABO

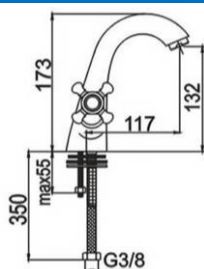

Monomando de lavabo. Montura cerámica de ¼ de vuelta. Conexiones flexibles certificadas 35 cm. Single lever basin mixer. ¼ turning opening. 35 cm certified flexible.

REF.	€	Caja
102005004	-	10



## KASTILA LV BIDÉ

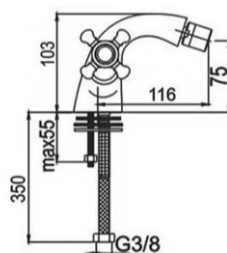

Monomando de bidé. Montura cerámica de ¼ de vuelta. Conexiones flexibles certificadas 35 cm. Single lever bidet mixer. ¼ turning opening. 35 cm certified flexible.

REF.	€	Caja
102005002	-	10

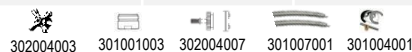

## KASTILA LV DUCHA

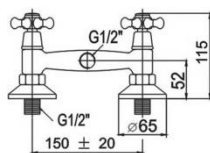

Monomando de ducha. Montura cerámica de ¼ de vuelta. Flexo, mango y soporte. Ceramic headparts ¼ turning opening. Flexo hose, handle and support.

REF.	€	Caja
102005003	-	10



## KASTILA LV BAÑO

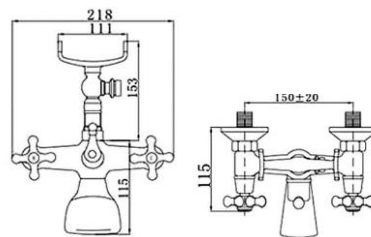

Monomando de baño. Montura cerámica de ¼ de vuelta. Flexo, mango y soporte. Ceramic headparts ¼ turning opening. Flexo hose, handle and support.

REF.	€	Caja
102005001	-	10





## KASTILA LV FREGADERO

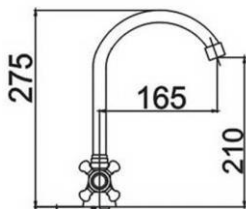

Monomando de fregadero monobloc. Montura cerámica 1/4 de vuelta. Caño giratorio. Conexiones flexibles certificadas 40 cm.

*Kitchen sink individual handle. 1/4 turn ceramic headparts. Swivel faucet. 40 cm certified flexible.*

REF.	€	Caja
203008001	-	12



## KASTILA LV FREGADERO RETRO

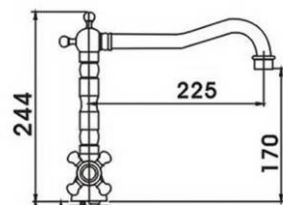

Monomando de fregadero monobloc. Montura cerámica 1/4 de vuelta. Caño giratorio. Conexiones flexibles certificadas 40 cm.

*Kitchen sink individual handle. 1/4 turn ceramic headparts. Swivel faucet. 40 cm certified flexible.*

REF.	€	Caja
203009001	-	8



## KASTILA LV KIT DUCHA

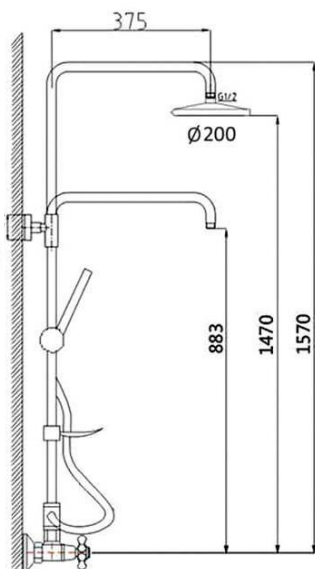

Conjunto kit ducha. Montura cerámica de 1/4 de vuelta. Rociador ABS 200 mm.

*Shower column with faucet. Ceramic headpart 1/4 turning opening. 200 mm ABS sprayer*

REF.	€	Caja
101004001	-	10





KROMER



## KARLA DUCHA

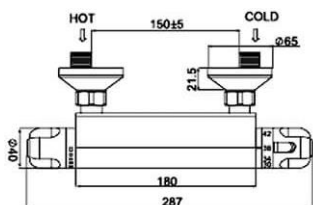

Termostática de ducha. Incluye flexo, mango y soporte.  
 Thermostatic shower mixer. Flexo hose, handle and support included.

REF.	€	Caja
103001001	-	10



## KARLA BAÑO

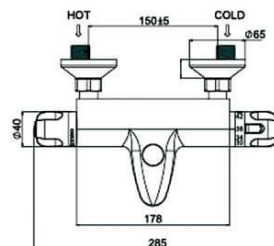

Termostática de baño. Incluye flexo, mango y soporte.  
 Thermostatic bath mixer. Flexo hose, handle and support included.

REF.	€	Caja
103001002	-	10



## KIRIA DUCHA

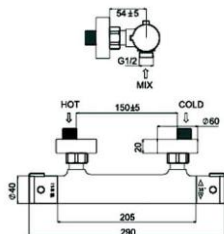

Termostática de ducha. Incluye flexo, mango y soporte.  
 Thermostatic shower mixer. Flexo hose, handle and support included.

REF.	€	Caja
103001003	-	10



## KIRIA DUAL PARA KIT

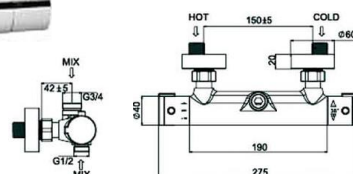

Termostática con salida dual para kit de ducha.  
 Thermostatic dual exit to shower kit mixer.

REF.	€	Caja
103001004	-	10



## KUBER DUCHA

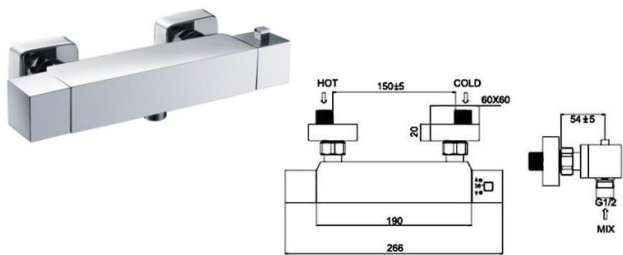

**Termostática de ducha. Incluye flexo, mango y soporte.**  
*Thermostatic shower mixer. Flexo hose, handle and support included.*

REF.	€	Caja
103001005	-	10



## KUBER DUAL PARA KIT

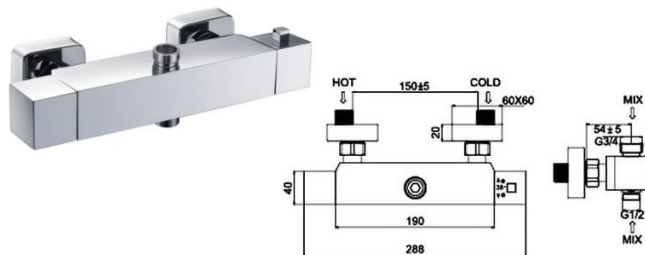

**Termostática con salida dual para kit de ducha.**  
*Thermostatic dual exit to shower kit mixer.*

REF.	€	Caja
103001006	-	10



# CONJUNTOS Y ACCESORIOS PARA DUCHA



KROMER



# ¿Quieres personalizar tu propia columna de ducha?



Desde Kromer te ayudamos a configurar tu propia columna de ducha eligiendo entre diferentes rociadores, mangos, flexos...

Rápido y sencillo.



## CONJUNTO KIT SIN GRIFO

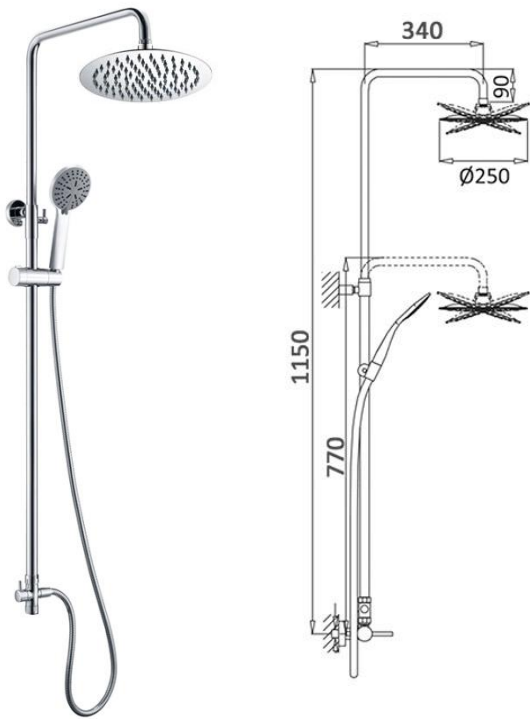

Conjunto kit ducha sin grifo. Adaptable a cualquier monomando o termostática con toma superior a 3/4.  
Shower system without tap. Adaptable to any single-lever or thermostatic valve with a connection larger than 3/4.

REF.	€	Caja
101007003	-	5



## CONJUNTO ESPECIAL BAÑO



Conjunto especial baño. Incluye inversor 2 salidas para flexo de 50 cm con soporte pared y flexo para telefonillo.  
Special bathroom set. Includes inverter with 2 outlets for 50 cm hose with wall support and telephone hose.

REF.	€	Caja
101007012	-	5



## KIT BASICO

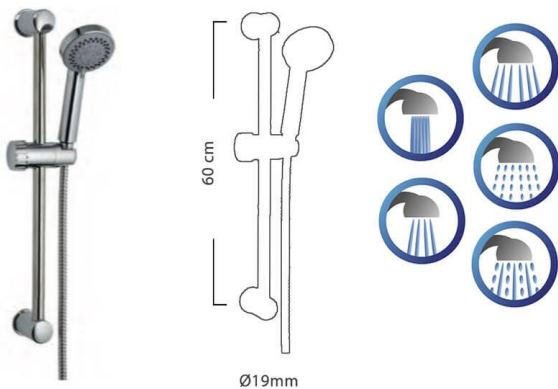

Kit barra, flexo 1,75 m y mango de ducha.  
Sliding bar with 1,75 m hose, handshower and support

REF.	€	Caja
101007004	-	10



## MONOM. PARA KIT KALUS

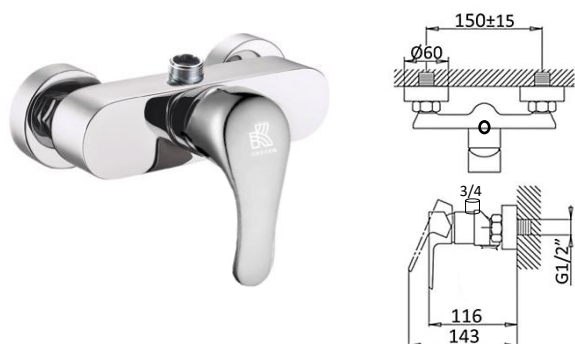

Monomando toma superior 3/4 para kit ducha.  
Single lever 3/4 upper intake for shower kit

REF.	€	Caja
102001008	-	10

## MONOM. PARA KIT KANIA



Monomando toma superior 3/4 para kit ducha.  
Single lever 3/4 upper intake for shower kit

REF.	€	Caja
102002005	-	10

## MONOM. PARA KIT KELENA



Monomando toma superior 3/4 para kit ducha.  
Single lever 3/4 upper intake for shower kit

REF.	€	Caja
102006005	-	10

## MONOM. PARA KIT KIRIA

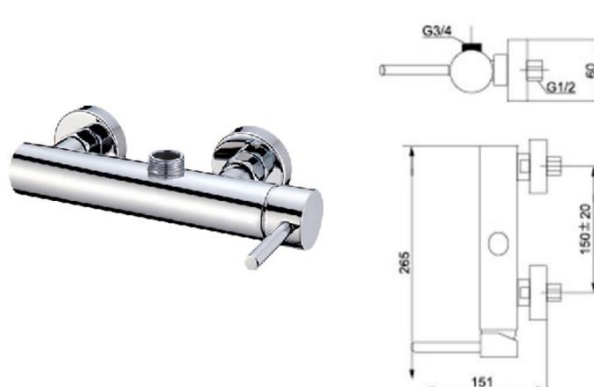

Monomando toma superior 3/4 para kit ducha.  
Single lever 3/4 upper intake for shower kit

REF.	€	Caja
102007008	-	10



## TERMOSTAT. PARA KIT KIRIA

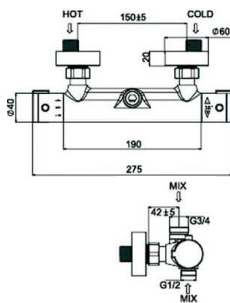

Termostática con salida dual para kit de ducha.  
Thermostatic dual exit to shower kit mixer.

REF.	€	Caja
103001004	-	10

302003001

## MONOM. PARA KIT KARES

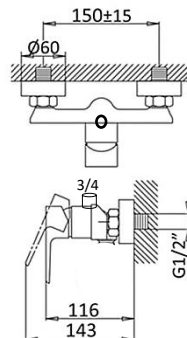

Monomando toma superior 3/4 para kit ducha.  
Single lever 3/4 upper intake for shower kit

REF.	€	Caja
102003008	-	10

## MONOM. PARA KIT KITIANA

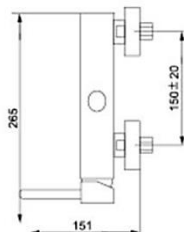

Monomando toma superior 3/4 para kit ducha.  
Single lever 3/4 upper intake for shower kit

REF.	€	Caja
102012010	-	10

## TERMOSTAT. PARA KIT KUBER

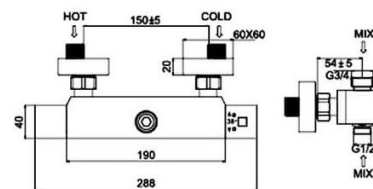

Termostática con salida dual para kit de ducha.  
Thermostatic dual exit to shower kit mixer.

REF.	€	Caja
103001006	-	10

302003001





## ROCIADOR ABS LATON VIEJO

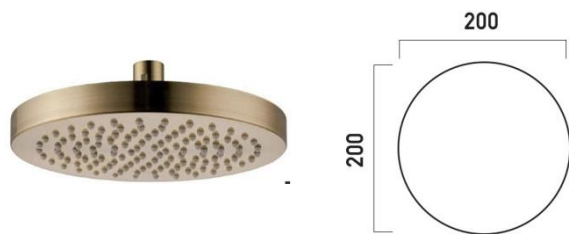

Rociador fabricado en ABS redondo de 20 cm acabado en latón viejo.

ABS shower head 20 cm old brass finished.

REF.	€	Caja
101002001	-	10

## ROCIADOR INOX NEGRO

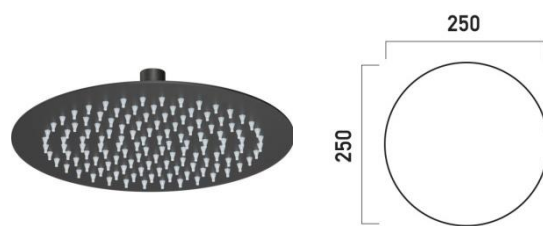

Rociador fabricado en acero inox AISI304. Redondo de 25 cm acabado en negro.

AISI304 stainless. Round black finished.

REF.	€	Caja
101002006	-	10

## ROCIADOR INOX REDONDO CROMO



Rociador fabricado en acero inox AISI304. Redondo acabado en cromo.

AISI304 stainless. Round chrome finished.

REF.	Medida	€	Caja
101002003	20 cm	-	10
101002005	25 cm	-	10
101002007	30 cm	-	10

## ROCIADOR INOX CUADRADO CROMO



Rociador fabricado en acero inox AISI304. Cuadrado acabado en cromo.

AISI304 stainless. Square chrome finished.

REF.	Medida	€	Caja
101002002	20 cm	-	10
101002004	25 cm	-	10
101002008	30 cm	-	10





## BRAZO DUCHA MURAL CR

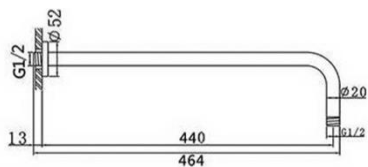

**Braço de ducha mural redondo.**  
Round wall shower arm.

REF.	€	Caja
101001002	-	10

## BRAZO DUCHA MURAL CR

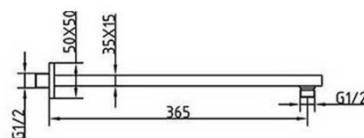

**Braço de ducha mural cuadrado.**  
Square wall shower arm.

REF.	€	Caja
101001001	-	10

## BRAZO DUCHA MURAL NEGRO

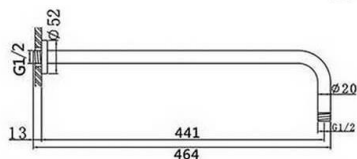

**Braço de ducha mural redondo.**  
Round wall shower arm.

REF.	€	Caja
101001004	-	10

## BRAZO DUCHA MURAL NEGRO

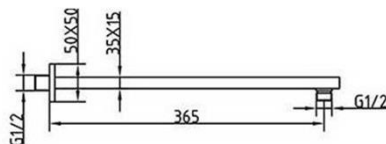

**Braço de ducha mural cuadrado.**  
Square wall shower arm.

REF.	€	Caja
101001003	-	10

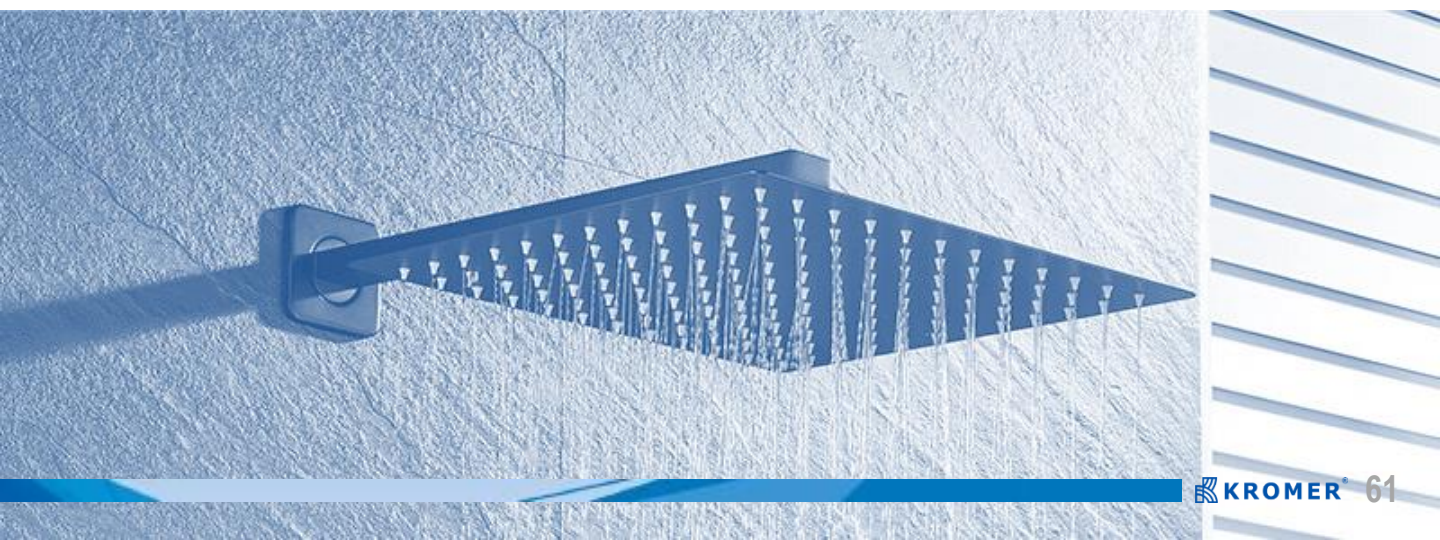

## BRAZO DUCHA TECHO CR

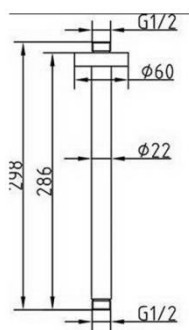

**Brazo de ducha techo redondo.**  
Round ceiling shower arm.

REF.	€	Caja
101001005	-	10

## BRAZO DUCHA TECHO CR

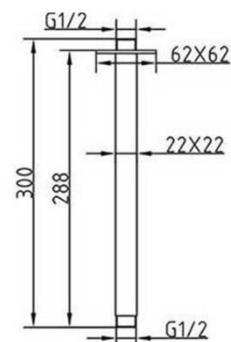

**Brazo de ducha techo cuadrado.**  
Square ceiling shower arm.

REF.	€	Caja
101001006	-	10

## BRAZO DUCHA TECHO NEGRO

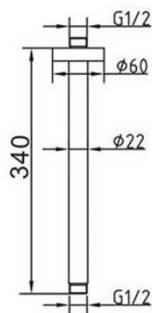

**Brazo de ducha techo redondo.**  
Round ceiling shower arm.

REF.	€	Caja
101001007	-	10

## BRAZO DUCHA TECHO NEGRO

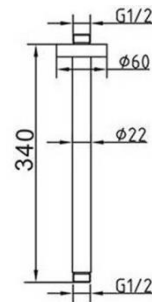

**Brazo de ducha techo cuadrado.**  
Square ceiling shower arm.

REF.	€	Caja
101001008	-	10



## MANGO DUCHA ECO



Mango ducha 3 posiciones cromo.  
3 position chrome handle shower .

REF.	€	Caja
302008003	-	10

## MANGO DUCHA BLANCO



Mango ducha 1 posición blanco.  
1 position white handle shower .

REF.	€	Caja
302008006	-	10

## MANGO DUCHA NEGRO



Mango ducha 1 posición negro.  
1 position black handle shower .

REF.	€	Caja
302008007	-	10

## MANGO DUCHA KALUS



Mango ducha 1 posición cromo.  
Basic 1 position handle shower .

REF.	€	Caja
302001005	-	10

## MANGO DUCHA KUBER/KARES



Mango ducha 1 posición cromo.  
Basic 1 position handle shower .

REF.	€	Caja
302003005	-	10

## MANGO DUCHA KUBER/KARES BLACK



Mango ducha 1 posición negro.  
1 position black handle shower .

REF.	€	Caja
302003010	-	10

## MANGO DUCHA SQUARE



Mango ducha 1 posición cromo.  
Basic 1 position handle shower .

REF.	€	Caja
302003011	-	10

## MANGO DUCHA KASTILA

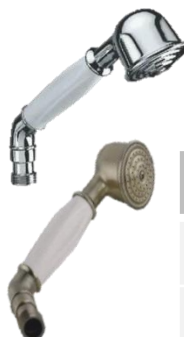

Mango ducha 1 posición .  
1 position handle shower .

REF.	€	Caja
302004006 CR	-	10
302004005 LV	-	10

## SOPORTE DUCHA KALUS



SopORTE eco para mango ducha.  
Shower support to handle shower .

REF.	€	Caja
301009002	-	10

## SOPORTE DUCHA ECO



SopORTE eco para mango ducha.  
Shower support to handle shower .

REF.	€	Caja
302003009	-	10

## SOPORTE DUCHA KUBER/KARES



SopORTE para mango ducha.  
Shower support to handle shower .

REF.	€	Caja
302003006	-	10

## SOPORTE DUCHA KIRIA



SopORTE para mango ducha.  
Shower support to handle shower .

REF.	€	Caja
302006009	-	10

## SOPORTE DUCHA KASTILA



SopORTE para mango ducha.  
Shower support to handle shower .

REF.	€	Caja
302007010 CR	-	10
302007011 LV	-	10



## SOPORTE DUCHA KUBER/KARES



SopORTE para mango ducha.  
Shower support to handle shower .

REF.	€	Caja
302003008	-	10

## SOPORTE DUCHA ECO BLACK



SopORTE para mango ducha.  
Shower support to handle shower .

REF.	€	Caja
302003010	-	10

## SOPORTE DUCHA CON TOMA



SopORTE con toma para mango ducha.  
Shower support to handle shower .

REF.	€	Caja
301009001	-	10

## FLEXO DUCHA EXTENSIBLE



Flexo ducha extensible 1,70-2,20 m.  
Shower hose 1,70-2,20 m.

REF.	€	Caja
301005005	-	10

## FLEXO DUCHA ESTANDAR



Flexo ducha estándar 1,70 m.  
Shower hose 1,70 m.

REF.	€	Caja
301005003	-	10

## FLEXO DUCHA BLANCO



Flexo ducha estándar 1,70 m.  
Shower hose 1,70 m.

REF.	€	Caja
301005001	-	10

## FLEXO DUCHA NEGRO



Flexo ducha estándar 1,70 m.  
Shower hose 1,70 m.

REF.	€	Caja
301005004	-	10

## FLEXO DUCHA BRONCE



Flexo ducha estándar 1,70 m.  
Shower hose 1,70 m.

REF.	€	Caja
301005010	-	10

## FLEXO DUCHA LATÓN VIEJO



Flexo ducha estándar 1,70 m.  
Shower hose 1,70 m.

REF.	€	Caja
301005002	-	10

## FLEXO PVC DUCHA CROMO



Flexo ducha PVC 1,70 m.  
PVC shower hose 1,70 m.

REF.	€	Caja
301005011	-	10

## FLEXO PVC DUCHA NEGRO



Flexo ducha PVC 1,50 m.  
PVC shower hose 1,50 m.

REF.	€	Caja
301005012	-	10



# COCINA

## *Kitchen*



Amplia variedad en grifería de cocina. Sea cual sea tu estilo o necesidad desde Kromer estamos seguros que tenemos un modelo para ti. Desde diseños sencillos y básicos hasta los más actuales y atrevidos. Haz de tu cocina el espacio favorito de la casa.



**Inoxidable**  
*Stainless*



**Abatible**  
*Folding spout*



**Extraíble**  
*Pull out spout*



**Osmosis**  
*Water treatment faucet*



 Ahorro de agua mediante nuestro aireadores de calidad.

 Grifería diseñada para equipos de tratamiento de agua.

 Grifería extraíble.



Grifería acabado inoxidable.



Fácil instalación.



**Diseño**  
*Design faucet*



**Mural**  
*Wall faucet*



**Cubetas inoxidables**  
*Stainless sinks*



**Cubetas de resina**  
*Fiberglass sinks*







## KAKI INOXIDABLE

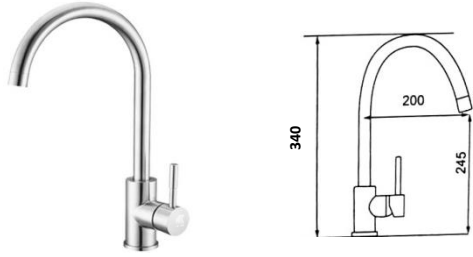

Monomando de fregadero. Cartucho cerámico de 35 mm. Apertura suave. Conexiones flexibles certificadas 40 cm. Single lever Kitchen mixer. 35 mm ceramic cartridge. Smooth opening. 40 cm certified flexible.

REF.	€	Caja
203002001	-	10



## KALYAN INOXIDABLE

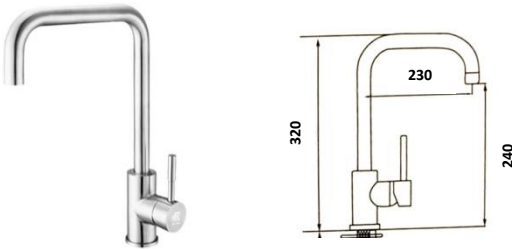

Monomando de fregadero. Cartucho cerámico de 35 mm. Apertura suave. Conexiones flexibles certificadas 40 cm. Single lever Kitchen mixer. 35 mm ceramic cartridge. Smooth opening. 40 cm certified flexible.

REF.	€	Caja
203003001	-	10



## KAMAR INOXIDABLE

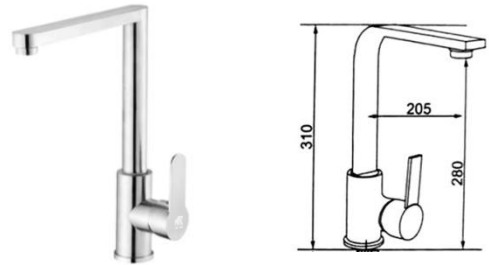

Monomando de fregadero. Cartucho cerámico de 35 mm. Apertura suave. Conexiones flexibles certificadas 40 cm. Single lever Kitchen mixer. 35 mm ceramic cartridge. Smooth opening. 40 cm certified flexible.

REF.	€	Caja
203004001	-	10



# KABAR ABATIBLE

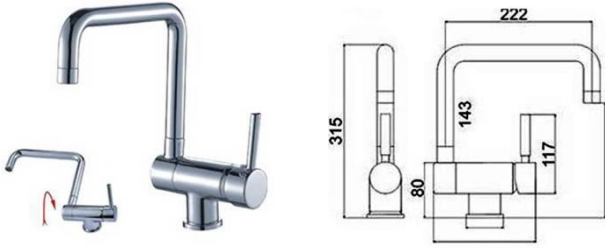

Monomando de fregadero. Cartucho cerámico de 35 mm. Apertura suave. Conexiones flexibles certificadas 40 cm. Single lever Kitchen mixer. 35 mm ceramic cartridge. Smooth opening. 40 cm certified flexible.

REF.	€	Caja
203019004	-	8

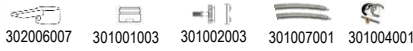

# K-OSMOS OSMOSIS

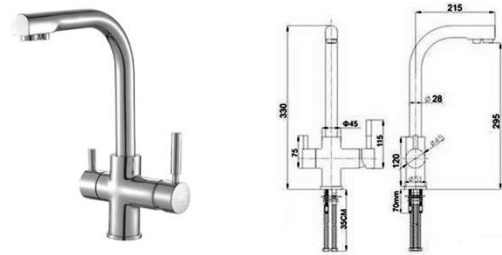

Monomando de fregadero para osmosis. Cartucho cerámico de 35 mm. Apertura suave. Conexiones flexibles certificadas 40 cm.

Single lever Kitchen mixer. Water treatment faucet. 35 mm ceramic cartridge. Smooth opening. 40 cm certified flexible.

REF.	€	Caja
203015001	-	8

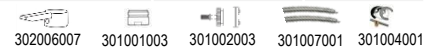





## KETIA EXTRAÍBLE

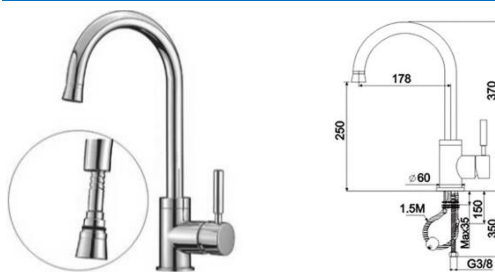

Monomando de fregadero extraíble. Cartucho cerámico de 35 mm. Apertura suave. Conexiones flexibles certificadas 40 cm.

Single lever Kitchen mixer with pull out shower. 35 mm ceramic cartridge. Smooth opening. 40 cm certified flexible.

REF.	€	Caja
203019003	-	8



## KIMERA BAJO EXTRAÍBLE



Monomando de fregadero extraíble. Cartucho cerámico de 40 mm. Apertura suave. Conexiones flexibles certificadas 40 cm.

Single lever Kitchen mixer with pull out shower. 40 mm ceramic cartridge. Smooth opening. 40 cm certified flexible.

REF.	€	Caja
203010006	-	12

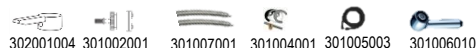

## KIMERA ALTO EXTRAÍBLE



Monomando de fregadero extraíble. Cartucho cerámico de 40 mm. Apertura suave. Conexiones flexibles certificadas 40 cm.

Single lever Kitchen mixer with pull out shower. 40 mm ceramic cartridge. Smooth opening. 40 cm certified flexible.

REF.	€	Caja
203010005	-	12

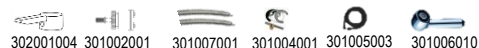



## KAMAR INOXIDABLE NEGRO

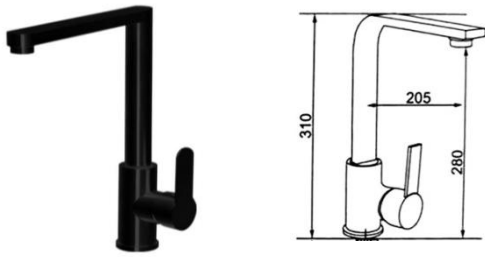

Monomando de fregadero. Cartucho cerámico de 35 mm. Apertura suave. Conexiones flexibles certificadas 40 cm. Single lever Kitchen mixer. 35 mm ceramic cartridge. Smooth opening. 40 cm certified flexible.

REF.	€	Caja
203004002	-	10



## KAIRO



Monomando de fregadero. Cartucho cerámico de 35 mm. Apertura suave. Conexiones flexibles certificadas 40 cm. Single lever Kitchen mixer. 35 mm ceramic cartridge. Smooth opening. 40 cm certified flexible.

REF.	€	Caja
203001102	-	8



## KARMA



Monomando de fregadero. Cartucho cerámico de 25 mm. Apertura suave. Conexiones flexibles certificadas 40 cm. Single lever Kitchen mixer. 25 mm ceramic cartridge. Smooth opening. 40 cm certified flexible.

REF.	€	Caja
203001103	-	8

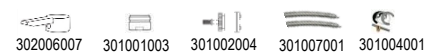

## KINDER NEGRO

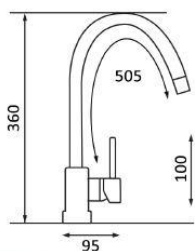

Monomando de fregadero flexible. Cartucho cerámico de 35 mm. Apertura suave. Conexiones flexibles certificadas 40 cm.

*Flexible single lever Kitchen mixer. 35 mm ceramic cartridge. Smooth opening. 40 cm certified flexible.*

REF.	€	Caja
203011002	-	10



## KINDER BLANCO

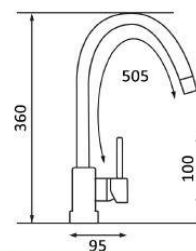

Monomando de fregadero flexible. Cartucho cerámico de 35 mm. Apertura suave. Conexiones flexibles certificadas 40 cm.

*Flexible single lever Kitchen mixer. 35 mm ceramic cartridge. Smooth opening. 40 cm certified flexible.*

REF.	€	Caja
203011001	-	10



## KOMAR NEGRO

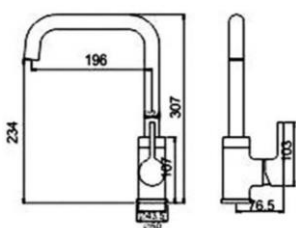

Monomando de fregadero. Cartucho cerámico de 35 mm. Apertura suave. Conexiones flexibles certificadas 40 cm.

*Single lever Kitchen mixer. 35 mm ceramic cartridge. Smooth opening. 40 cm certified flexible.*

REF.	€	Caja
203001101	-	10



## KOMAR BLANCO

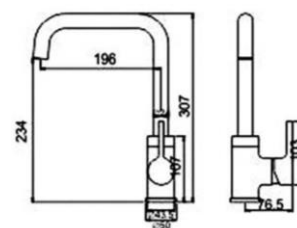

Monomando de fregadero. Cartucho cerámico de 35 mm. Apertura suave. Conexiones flexibles certificadas 40 cm.

*Single lever Kitchen mixer. 35 mm ceramic cartridge. Smooth opening. 40 cm certified flexible.*

REF.	€	Caja
203001100	-	10







# KAUS

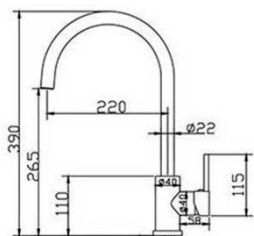

Monomando de fregadero . Cartucho cerámico de 35 mm.  
Apertura suave. Conexiones flexibles certificadas 40 cm.  
Single lever Kitchen mixer. 35 mm ceramic cartridge.  
Smooth opening. 40 cm certified flexible.

REF.	€	Caja
203019002	-	8

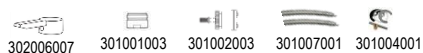

# KUBER

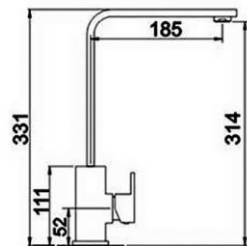

Monomando de fregadero. Cartucho cerámico de 35 mm.  
Apertura suave. Conexiones flexibles certificadas 40 cm.  
Single lever Kitchen mixer. 35 mm ceramic cartridge. Smooth opening. 40 cm certified flexible.

REF.	€	Caja
203006004	-	10





## KASTILA CROMO

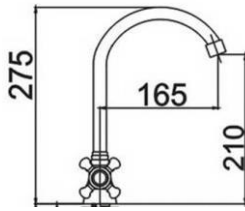

Monomando de fregadero monobloc. Montura cerámica 1/4 de vuelta. Caño giratorio. Conexiones flexibles certificadas 40 cm.

*Kitchen sink individual handle. 1/4 turni ceramic headparts. Swivel faucet. 40 cm certified flexible.*

REF.	€	Caja
203008002	-	12



## KASTILA RETRO CROMO

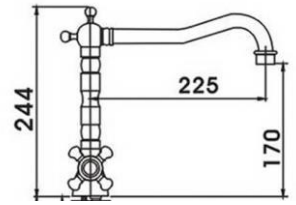

Monomando de fregadero monobloc. Montura cerámica 1/4 de vuelta. Caño giratorio. Conexiones flexibles certificadas 40 cm.

*Kitchen sink individual handle. 1/4 turni ceramic headparts. Swivel faucet. 40 cm certified flexible.*

REF.	€	Caja
203009002	-	8



## KASTILA LATON VIEJO

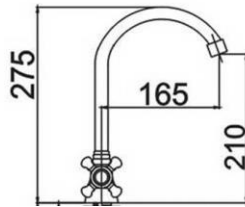

Monomando de fregadero monobloc. Montura cerámica 1/4 de vuelta. Caño giratorio. Conexiones flexibles certificadas 40 cm.

*Kitchen sink individual handle. 1/4 turni ceramic headparts. Swivel faucet. 40 cm certified flexible.*

REF.	€	Caja
203008001	-	12



## KASTILA RETRO LATON VIEJO

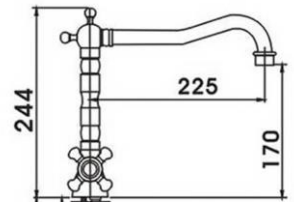

Monomando de fregadero monobloc. Montura cerámica 1/4 de vuelta. Caño giratorio. Conexiones flexibles certificadas 40 cm.

*Kitchen sink individual handle. 1/4 turni ceramic headparts. Swivel faucet. 40 cm certified flexible.*

REF.	€	Caja
203009001	-	8



## KLARA

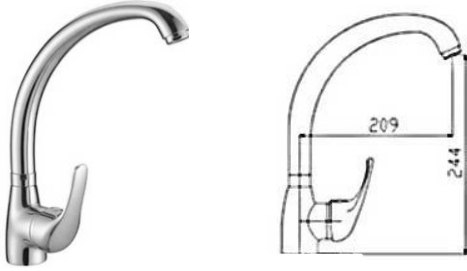

Monomando de fregadero . Caño conformado. Cartucho cerámico de 40 mm. Apertura suave. Conexiones flexibles certificadas 40 cm.

*Single lever Kitchen mixer. 40 mm ceramic cartridge. Smooth opening.40 cm certified flexible.*

REF.	€	Caja
203013001	-	10

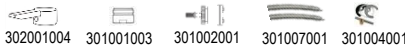

## KIOTO

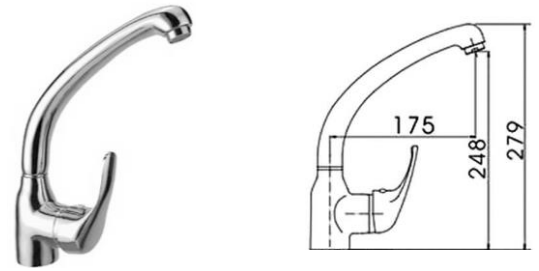

Monomando de fregadero . Caño fundido. Cartucho cerámico de 40 mm. Apertura suave. Conexiones flexibles certificadas 40 cm.

*Single lever casted high spout kitchen mixer. 40 mm ceramic cartridge. Smooth opening.40 cm certified flexible.*

REF.	€	Caja
203012001	-	10

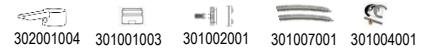

## KANDI

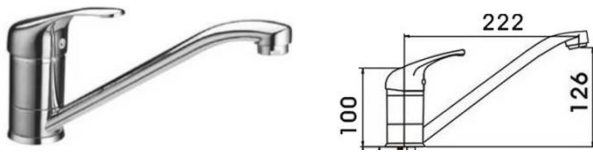

Monomando de fregadero . Caño conformado. Cartucho cerámico de 40 mm. Apertura suave. Conexiones flexibles certificadas 40 cm.

*Single lever Kitchen mixer. 40 mm ceramic cartridge. Smooth opening.40 cm certified flexible.*

REF.	€	Caja
203005001	-	10

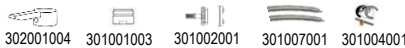

## KAREN

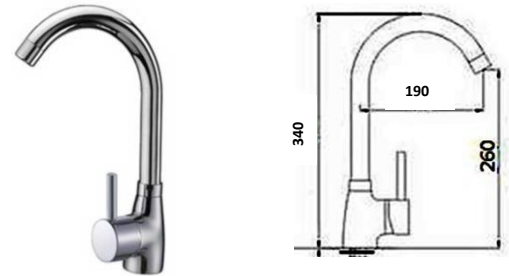

Monomando de fregadero. Cartucho cerámico de 40 mm. Apertura suave. Conexiones flexibles certificadas 40 cm.

*Single lever Kitchen mixer. 40 mm ceramic cartridge. Smooth opening.40 cm certified flexible.*

REF.	€	Caja
203007001	-	10

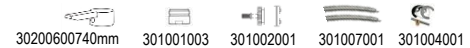

## KARANDA CAÑO FORMA 15

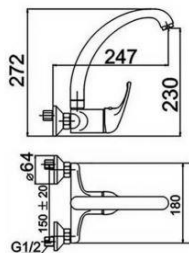

Monomando mural de fregadero . Caño conformado. Cartucho cerámico de 40 mm. Apertura suave. Wall Single lever Kitchen mixer. 40 mm ceramic cartridge. Smooth opening.

REF.	€	Caja
203006002	-	10



## KARANDA CAÑO FORMA 11

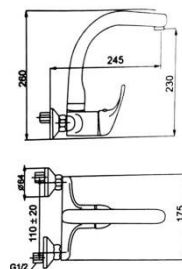

Monomando mural de fregadero . Caño conformado. Cartucho cerámico de 40 mm. Apertura suave. Wall Single lever Kitchen mixer. 40 mm ceramic cartridge. Smooth opening.

REF.	€	Caja
203001105	-	10



## KARANDA CAÑO FUNDIDO

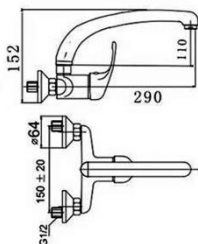

Monomando de fregadero . Caño fundido. Cartucho cerámico de 40 mm. Apertura suave. Single lever Kitchen mixer. Cast brass spout. 40 mm ceramic cartridge. Smooth opening.

REF.	€	Caja
203006003	-	10



## KARANDA CAÑO INFERIOR

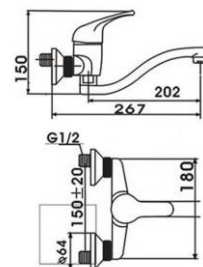

Monomando mural de fregadero . Caño conformado. Cartucho cerámico de 40 mm. Apertura suave. Wall Single lever Kitchen mixer. 40 mm ceramic cartridge. Smooth opening.

REF.	€	Caja
203006001	-	10



## BATERÍA FREGADERO 11

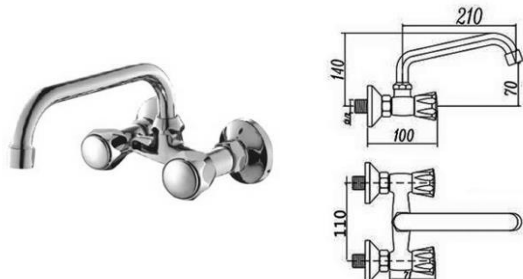

Batería mural de fregadero . Caño giratorio. Montura cerámica de 1/4 de vuelta.

Wall mounted kitchen mixer 11cm. 1/4 turn ceramic headparts. High swivel sput shape.

REF.	€	Caja
203010001	-	10

301001003 302001002 302004009

## BATERÍA FREGADERO 15

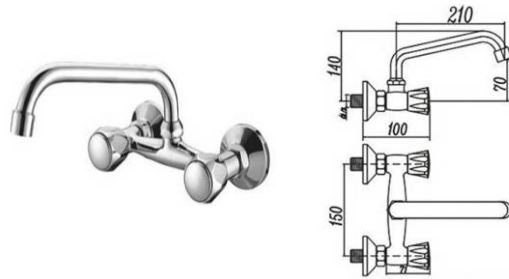

Batería mural de fregadero . Caño giratorio. Montura cerámica de 1/4 de vuelta.

Wall mounted kitchen mixer 15cm. 1/4 turn ceramic headparts. High swivel sput shape.

REF.	€	Caja
203010002	-	10

301001003 302001002 302004009

## GRIFO 1 AGUA VERTICAL

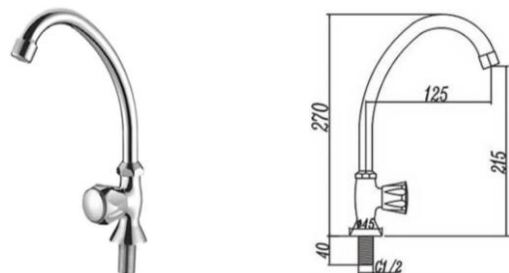

Grifo giratorio vertical Caño giratorio. Montura cerámica de 1/4 de vuelta.

kitchen faucet 1/4 turn ceramic headparts. High swivel sput shape.

REF.	€	Caja
203010004	-	10

301001003 302004009

## GRIFO 1 AGUA HORIZONTAL

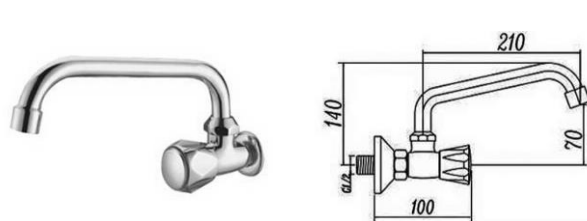

Grifo giratorio horizontal Caño giratorio. Montura cerámica de 1/4 de vuelta.

Wall mounted kitchen 1/4 turn ceramic headparts. High swivel sput shape.

REF.	€	Caja
203010003	-	10

301001003 302001002 302004009





## MONOMANDO 1 AGUA VERT.

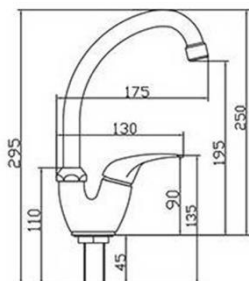

Monomando 1 agua vertical. Caño giratorio. Cartucho cerámico 25 mm.

Single lever kitchen sink. Turninf faucet. 25 mm ceramic castridge.

REF.	€	Caja
203001104	-	10



## MONOMANDO MURAL ALTO

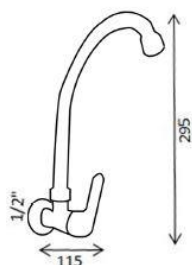

Monomando de un agua con cartucho de 25 mm.

Single-lever water mixer with 25 mm cartridge.

REF.	€	Caja
203010007	-	10



## MONOMANDO MURAL BAJO

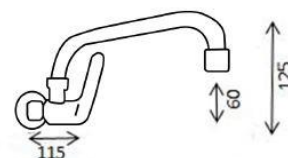

Monomando de un agua mural con cartucho de 25 mm.

Wall-mounted single-lever water mixer with 25 mm cartridge.

REF.	€	Caja
203010008	-	10





CUBETAS PARA



# FREGADERO



KROMER

## CUBETA INOX. CUADRADA

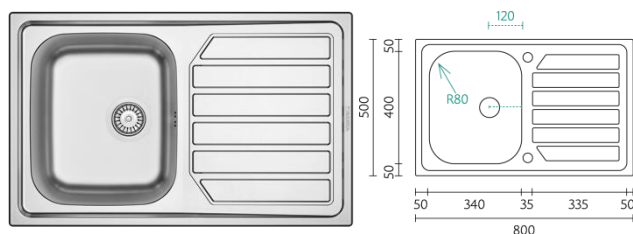

Cubeta para fregadero fabricado en acero inoxidable. Un seno con escurridor. Incluye válvula. Posibilidad de orificio (Indicar lado del escurridor). Profundidad de la cubeta 170 mm. Recomendado para mueble de 800 mm.

*Sink bowl made of stainless steel. A sink with drainer. Includes valve. Possibility of hole (Indicate drainer side) Depth of the tray 170 mm. Recommended for 800 mm furniture.*

REF.	€	Caja
201001001	-	5

## CUBETA INOX. CUADRADA

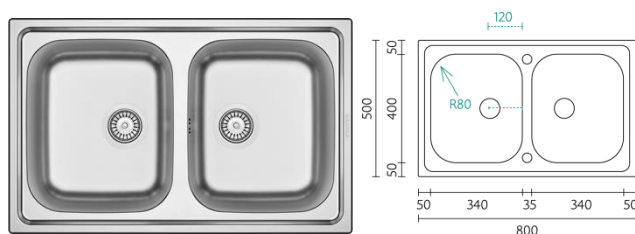

Cubeta para fregadero fabricado en acero inoxidable. Dos senos. Incluye válvula. Profundidad de la cubeta 170 mm. Recomendado para mueble de 800 mm.

*Sink bowl made of stainless steel. A sink with two buckets. Includes valve. Depth of the tray 170 mm. Recommended for 800 mm furniture.*

REF.	€	Caja
201001002	-	5

## CUBETA INOX. CUADRADA



Cubeta para fregadero fabricado en acero inoxidable. Un seno bajo encimera. Incluye válvula. Profundidad de la cubeta 180 mm. Recomendado para mueble de 500 mm.

*Sink bowl made of stainless steel. A sink under counter. Includes valve. Depth of the tray 180 mm. Recommended for 500 mm furniture.*

REF.	€	Caja
201001003	-	5

## CUBETA INOX. CUADRADA

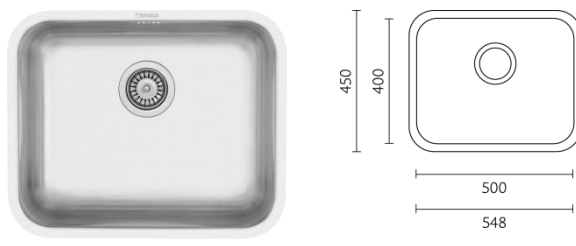

Cubeta para fregadero fabricado en acero inoxidable. Un seno bajo encimera. Incluye válvula. Profundidad de la cubeta 180 mm. Recomendado para mueble de 600 mm.

*Sink bowl made of stainless steel. A sink under counter. Includes valve. Depth of the tray 180 mm. Recommended for 600 mm furniture.*

REF.	€	Caja
201001004	-	5





## CUBETA INOX. CUADRADA

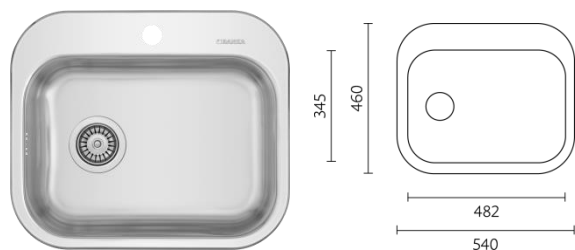

Cubeta para fregadero fabricado en acero inoxidable. Un seno. Incluye válvula. Con orificio. Profundidad de la cubeta 160 mm. Recomendado para mueble de 600 mm.

*Sink bowl made of stainless steel. A breast. Includes valve. With hole. Depth of the tray 160 mm. Recommended for 600 mm furniture.*

REF.	€	Caja
201001005	-	5

## CUBETA INOX. REDONDO

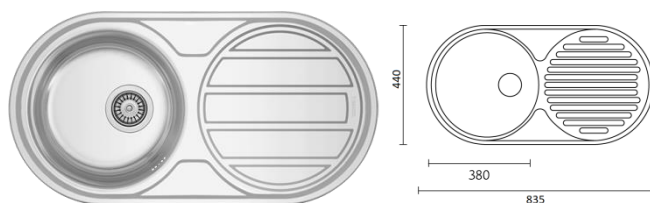

Cubeta para fregadero fabricado en acero inoxidable. Un seno con escurridor. Incluye válvula. Posibilidad de orificio (Indicar lado del escurridor). Profundidad de la cubeta 150 mm. Recomendado para mueble de 600 mm.

*Sink bowl made of stainless steel. A sink with drainer. Includes valve. Possibility of hole (Indicate drainer side) Depth of the tray 150 mm. Recommended for 600 mm furniture.*

REF.	€	Caja
201002001	-	5

## CUBETA INOX. REDONDO

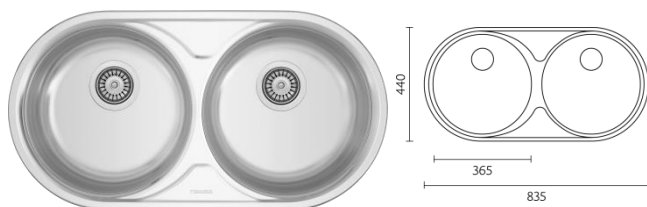

Cubeta para fregadero fabricado en acero inoxidable. Dos senos. Incluye válvula. Posibilidad de orificio. Profundidad de la cubeta 150 mm. Recomendado para mueble de 800 mm.

*Sink bowl made of stainless steel. Two sinks. Includes valve. Possibility of hole. Depth of the tray 150 mm. Recommended for 800 mm furniture.*

REF.	€	Caja
201002002	-	5

## CUBETA INOX. REDONDO



Cubeta para fregadero fabricado en acero inoxidable. Un seno. Sobre y bajo encimera. Incluye válvula. Profundidad de la cubeta 160 mm. Recomendado para mueble de 450 mm.

*Sink bowl made of stainless steel. One sink. Above and below installation. Includes valve. Depth of the tray 160 mm. Recommended for 450 mm furniture.*

REF.	€	Caja
201002003	-	5



## CUBETA INOX. REDONDO

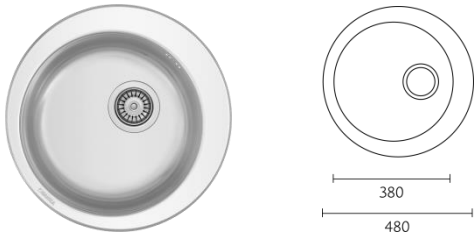

Cubeta para fregadero fabricado en acero inoxidable. Un seno. Incluye válvula. Con orificio. Profundidad de la cubeta 160 mm. Recomendado para mueble de 600 mm.

*Sink bowl made of stainless steel. A breast. Includes valve. With hole. Depth of the tray 160 mm. Recommended for 600 mm furniture.*

REF.	€	Caja
201002004	-	5

## CUBETA RESINA ZENTIA4040



Cubeta para fregadero fabricado en fibra de vidrio. Un seno. Sobre y bajo encimera. Incluye válvula. Profundidad de la cubeta 200 mm. Recomendado para mueble de 450 mm.

*Sink bowl made of fiberglass. One sink. Above and below installation. Includes valve. Depth of the tray 200 mm. Recommended for 450 mm furniture.*

REF.	Acabados	€	Caja
201002005		-	1

## CUBETA RESINA ZENTIA5040



Cubeta para fregadero fabricado en fibra de vidrio. Un seno. Sobre y bajo encimera. Incluye válvula. Profundidad de la cubeta 200 mm. Recomendado para mueble de 600 mm.

*Sink bowl made of fiberglass. One sink. Above and below installation. Includes valve. Depth of the tray 200 mm. Recommended for 600 mm furniture.*

REF.	Acabados	€	Caja
201002006		-	1

## CUBETA RESINA DOMUSR1C1E



Cubeta para fregadero fabricado en fibra de vidrio. Un seno con escurridor. Incluye válvula. Posibilidad de orificio (Indicar lado del escurridor). Profundidad de la cubeta 170 mm. Recomendado para mueble de 450 mm.

*Sink bowl made of fiberglass. A sink with drainer. Includes valve. Possibility of hole (Indicate drainer side) Depth of the tray 170 mm. Recommended for 450 mm furniture.*

REF.	Acabados	€	Caja
201002007		-	1

## CUBETA RESINA ZENTIABEE2C 8350





Cubeta para fregadero fabricado en fibra de vidrio. Dos senos. Sobre encimera. Incluye válvula. Profundidad de la cubeta 208 mm.

Recomendado para mueble de 800 mm.

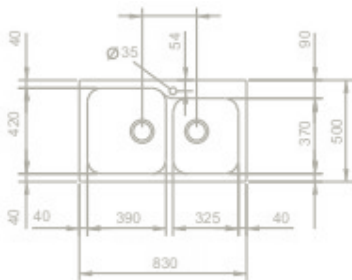
*Sink bucket made of fiberglass. Two breasts. On countertop. Includes valve. Depth of the tray 208 mm. Recommended for 800 mm furniture.*



REF.	Acabados	€	Caja
201002008	   	-	1

## CUBETA RESINA DOMUSR2C 8444

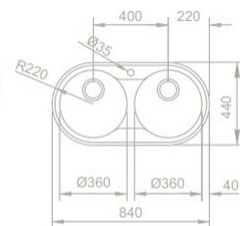

Cubeta para fregadero fabricado en fibra de vidrio. Dos senos. Sobre encimera. Incluye válvula. Profundidad de la cubeta 212 mm. Recomendado para mueble de 800 mm.

*Sink bucket made of fiberglass. Two breasts. On countertop. Includes valve. Depth of the tray 212 mm. Recommended for 800 mm furniture.*

REF.	Acabados	€	Caja
201002009	   	-	1

## CUBETA RESINA ESENCIA 1C1E 8650

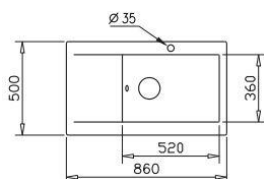

Cubeta para fregadero fabricado en fibra de vidrio. Un seno y escurridor. Sobre encimera. Incluye válvula. Profundidad de la cubeta 220 mm. Recomendado para mueble de 600 mm.

*Sink bowl made of fiberglass. One sink with drainer. Above installation. Includes valve. Depth of the tray 220 mm. Recommended for 600 mm furniture.*

REF.	Acabados	€	Caja
201002010	  	-	1

## CUBETA RESINA DOMUS BEE R430

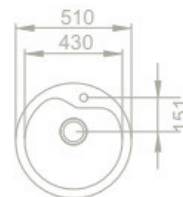

Cubeta para fregadero fabricado en fibra de vidrio. Un seno. Incluye válvula. Instalación sobre y bajo encimera. Profundidad de la cubeta 202 mm. Recomendado para mueble de 500 mm y si es bajo encimera mínimo 600 mm.

REF.	Acabados	€	Caja
201002011	   	-	1



# LAVABOS





CERÁMICOS



KROMER

## DUATI

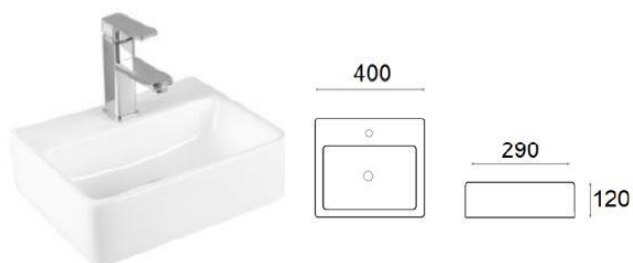

### Lavabo tipo bol sobre encimera.

Color blanco.

Medidas: 40 cm ancho x 29 cm profundidad x 12 cm alto

REF.	€	Caja
106001006	-	1

## LENUS

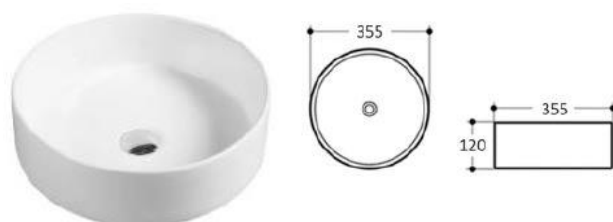

### Lavabo tipo bol sobre encimera.

Color blanco.

Medidas: 35,5 cm diámetro x 12 cm alto

REF.	€	Caja
106001007	-	1

## SABIA

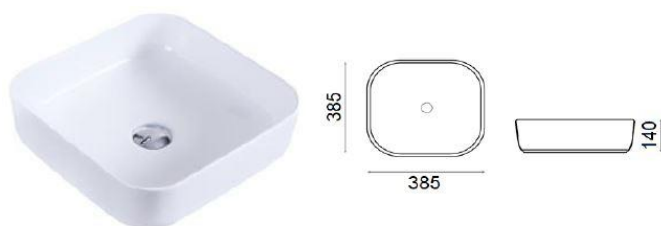

### Lavabo tipo bol sobre encimera.

Color blanco.

Medidas: 38,5 cm ancho x 38,5 cm profundidad x 14 cm alto

REF.	€	Caja
106001009	-	1

## SABIA BLACK



### Lavabo tipo bol sobre encimera.

Color blanco.

Medidas: 38,5 cm ancho x 38,5 cm profundidad x 14 cm alto

REF.	€	Caja
106001010	-	1



# MIMO

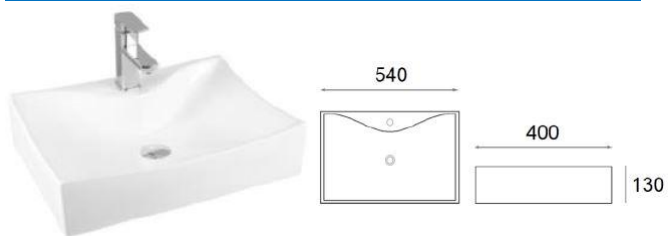

**Lavabo tipo bol sobre encimera.**

Color blanco.

Medidas: 54 cm ancho x 40 cm profundidad x 13 cm alto

REF.	€	Caja
106001008	-	1





# GRIFERIA







TÉCNICA



## TEMPORIZ. LAVABO 2 AGUAS

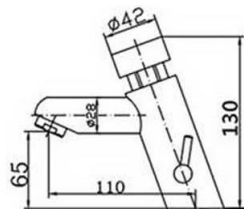

Grifo temporizado de dos aguas. Conexiones 40 cm certificadas. Duración del caudal: 8-12 segundos.

Timer basing mixer hot and cold water. 40 cm certified flexible. Flow duration: 8-12 seconds.

REF.	€	Caja
401003001	-	10

301007001 302002002

## TEMPORIZ. LAVABO 1 AGUA

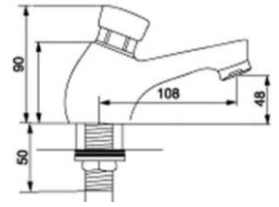

Grifo temporizado de un agua. Duración del caudal: 8-12 segundos.

Timer basing tap. Flow duration: 8-12 seconds.

REF.	€	Caja
401003002	-	10

302002002

## TEMPORIZ. PILETA

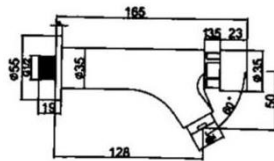

Grifo temporizado mural para pileta. Duración del caudal: 8-12 segundos.

Wall mounted timer basing tap. Flow duration: 8-12 seconds.

REF.	€	Caja
401005001	-	10

302002002

## GRIFO BEBEDERO

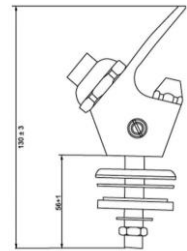

Grifo bebedero para fuente.

Drinking fountain tap.

REF.	€	Caja
401002001	-	10



## TEMPOR. DUCHA EMPOTRAR

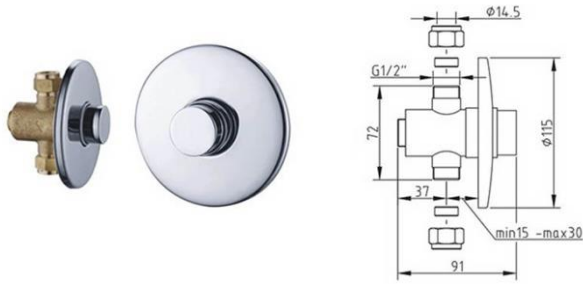

Ducha temporizada para empotrar.  
Built-in timer shower mixer. Flow duration: 8-12 seconds.

REF.	€	Caja
401001001	-	10

302002002

## FLUXOMETRO URINARIO

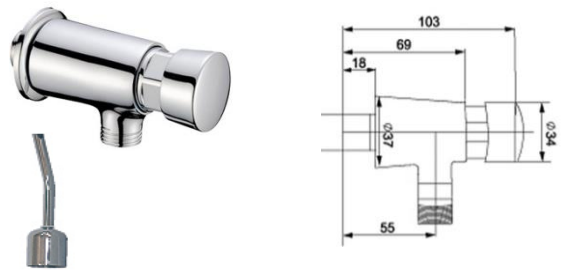

Flujómetro para urinario. Duración del caudal 8-12 segundos.

Timer urinary wall faucet. Flow duration: 8-12 seconds.

REF.	€	Caja
401006001	-	10

\*CONSULTAR DESPIECE 302002002

## FLUXOMETRO PEDAL 1 AGUA

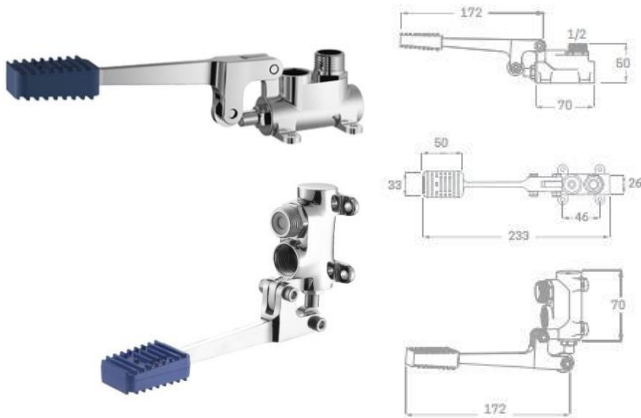

Flujómetro pedal 1 agua. Instalación pared o suelo.  
Pedal flushometer 1 water. Wall or floor installation.

REF.	€	Caja
401004002	-	10

\*CONSULTAR DESPIECE 301002005

## FLUXOMETRO PEDAL 2 AGUAS

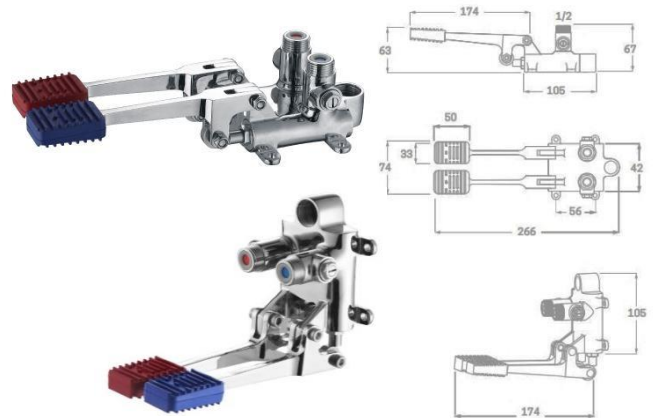

Flujómetro pedal 2 aguas. Instalación pared o suelo.  
Pedal flushometer 2 waters. Wall or floor installation.

REF.	€	Caja
401004003	-	10

\*CONSULTAR DESPIECE 301002006



## FLUXOMETRO PEDAL MEZCLADOR

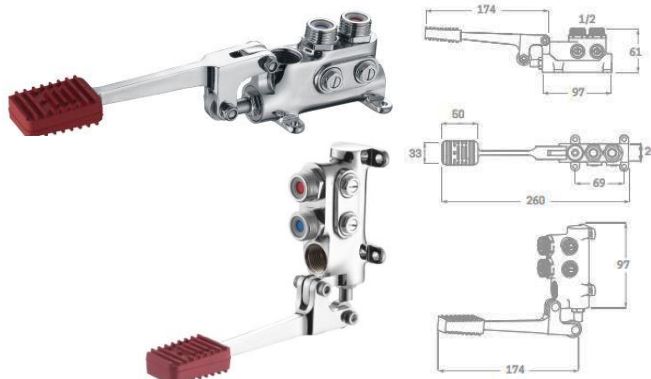

Fluxómetro pedal mezclador. Instalación pared o suelo. Temperatura regulable. Mixer pedal flushometer. Wall or floor installation. Adjustable temperature.

REF.	€	Caja
401004004	-	10

\*CONSULTAR DESPIECE  302002006

## CAÑO PARA FLUXOMETRO



Caño giratorio para fluxómetro. Turning sink faucet.

REF.	€	Caja
401004001	-	10

## KSENSOR 1 AGUA

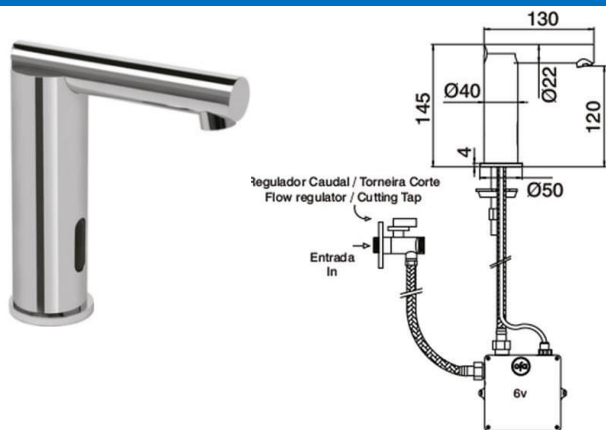

Grifo electrónico 1 agua. 6 V. Pilas Infrared basing tap 6V.

REF.	€	Caja
401007110	-	10

\*CONSULTAR DESPIECE

## KSENSOR MEZCLADOR

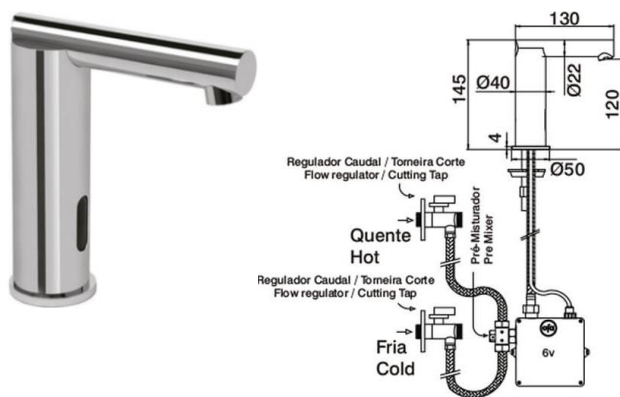

Grifo electrónico mezclador. 6 V. Pilas Infrared basing pre-mixer tap 6V.

REF.	€	Caja
401007111	-	10

\*CONSULTAR DESPIECE





## MONOMANDO LAVABO 1 AGUA

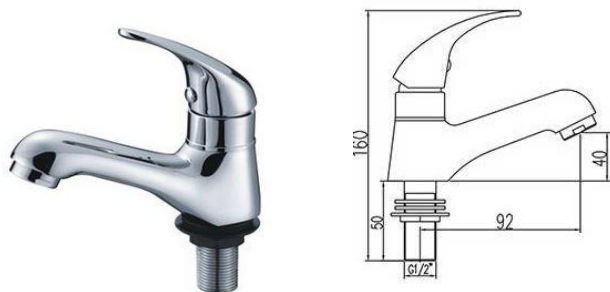

Monomando 1 agua básico. Cartucho cerámico 25 mm.  
Basing tap 1 water. 25 mm ceramic cartridge.

REF.	€	Caja
401100114	-	10

302002004

## MONOMANDO DUCHA MEDICAL

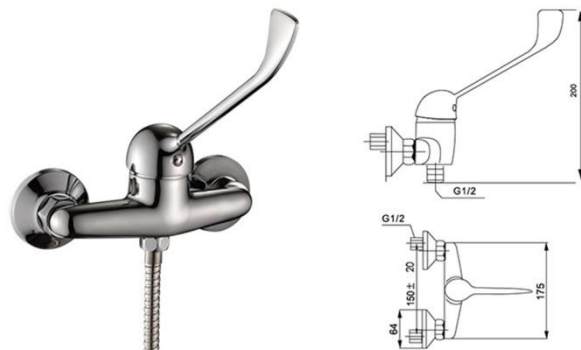

Monomando ducha palanca medical. Cartucho cerámico 40 mm. Single lever shower mixer with long lever handle. 40 mm ceramic cartridge

REF.	€	Caja
401100120	-	10

401100118 301002001 302001002 302001005 301005003 301009002

## MONOMANDO MEDICAL LAVABO

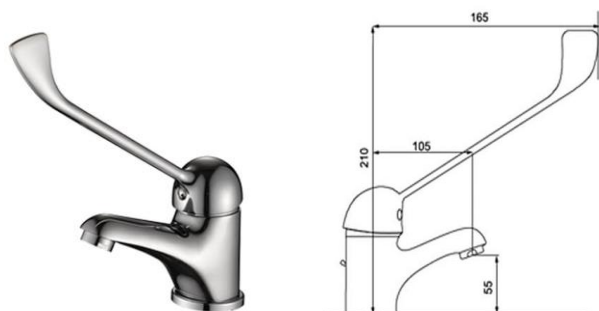

Monomando lavabo palanca medical. Cartucho cerámico 40 mm. Basing mixer long lever handle. 40 mm ceramic cartridge

REF.	€	Caja
401100115	-	10

401100118 301001003 301002001 301007001 301004001

## MONOMANDO MEDICAL FREG.

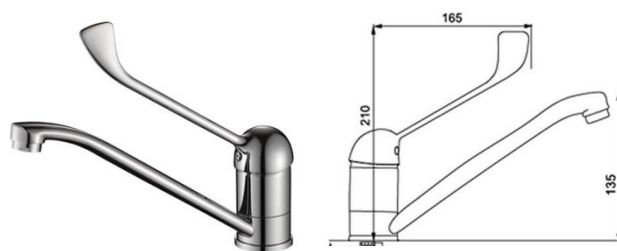

Monomando fregadero palanca medical. Cartucho cerámico 40 mm. Sink mixer long lever handle. 40 mm ceramic cartridge

REF.	€	Caja
401100116	-	10

401100118 301001003 301002001 301007001 301004001



## MONOMANDO MURAL MEDICAL

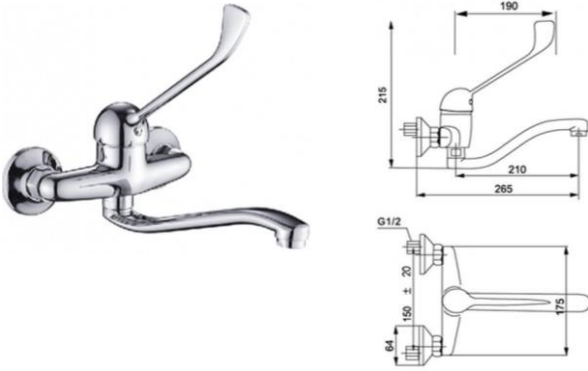

Monomando mural con palanca medical. Cartucho cerámico 40 mm. Wall sink mixer swivel spout long handle. 40 mm ceramic cartridge.

REF.	€	Caja
401100117	-	10

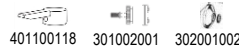

## GRIFO MURAL 1 AGUA MEDICAL

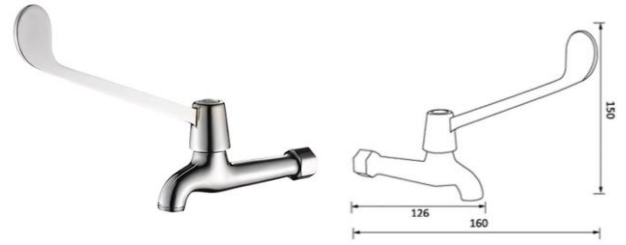

Grifo mural de 1 agua con palanca medical. Lever medical handle 1 water wall tap.

REF.	€	Caja
401100119	-	10

## KIMERA BAJO EXTRA. MEDICAL

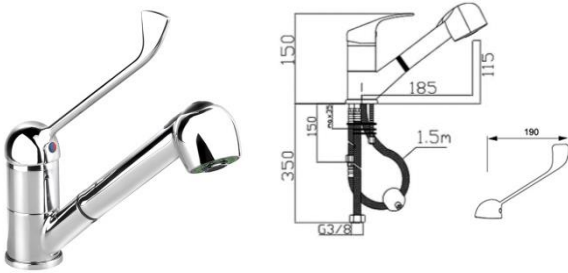

Monomando de fregadero extraible. Cartucho cerámico de 40 mm. Apertura suave. Conexiones flexibles certificadas 40 cm.

Single lever Kitchen mixer with pull out shower. 40 mm ceramic cartridge. Smooth opening. 40 cm certified flexible.

REF.	€	Caja
401100121	-	12



## PALANCA MEDICAL



Palanca medical para cartucho cerámico 40 mm. Lever medical handle for 40 mm ceramic cartridge

REF.	€	Caja
401100118	-	10





COLECTI



VIDADES



KROMER

## DOSIFICADOR DE JABÓN

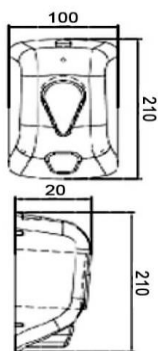

Dosificador de jabón también apto para gel hidroalcohólico. Fabricado en ABS. 1 litro de capacidad. ABS Soap dispenser. 1 L.

REF.	€	Caja
502001002	-	10

## DOSIFICADOR JABÓN ANTIVANDÁLICO

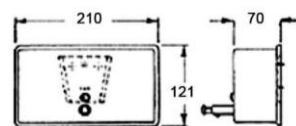

Dosificador inoxidable antivandálico. 1,2 litros. Stainless vandal proof soap dispenser.

REF.	€	Caja
502002003	-	10

## PORTARROLLO INOX. SATINADO

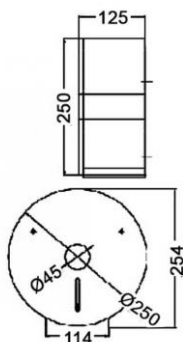

Portarrollos inoxidable acabado satinado. Stainless toilet roll holder. Satin finished.

REF.	€	Caja
502002002	-	10

## PORTARROLLO INOX. BLANCO

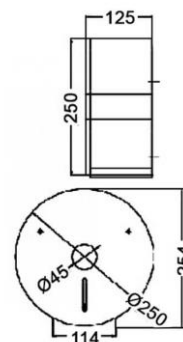

Portarrollos inoxidable acabado blanco. Stainless toilet roll holder. White finished.

REF.	€	Caja
502002001	-	10

## SECAMANOS CON SENSOR

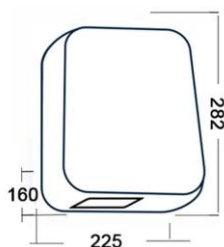

Secamanos con sensor. Acero inoxidable acabado satinado. Vel. 13 m/s, Peso: 3 Kg. Stainless steel hand dryer. 13 m/s airspeed. 3 Kg weight.

REF.	€	Caja
502004001	-	10

## SECAMANOS CON SENSOR

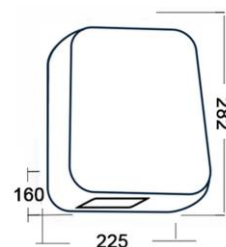

Secamanos con sensor. Acero inoxidable acabado blanco. Vel. 13 m/s, Peso: 3 Kg. Stainless steel hand dryer. White finished. 13 m/s airspeed. 3 Kg weight.

REF.	€	Caja
502004002	-	10

## SECAMANOS CON SENSOR EKO

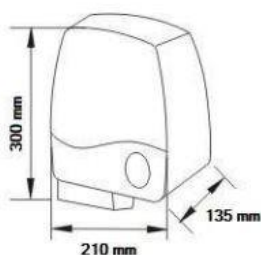

Secamanos con sensor en ABS blanco. Automático con sensor infrarrojos. Dimensiones: 300 x 210 x 135 mm. Hand dryer with sensor in white ABS. Automatic with infrared sensor. Dimensions: 300 x 210 x 135 mm.

REF.	€	Caja
502005002	-	10

## SECADOR PELO PISTOLA

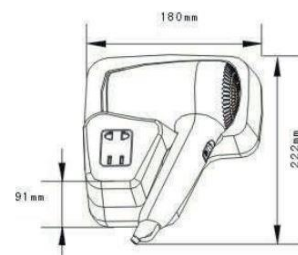

Secador pelo pistola. ABS. Dos velocidades. 600/1200 W. 185 x 215 x 205 mm. ABS hair dryer gun. Two speed 600/1200 W. 185 x 215 x 205 mm.

REF.	€	Caja
502005001	-	10







# TÉCNICAS

## BARRA ABATIBLE

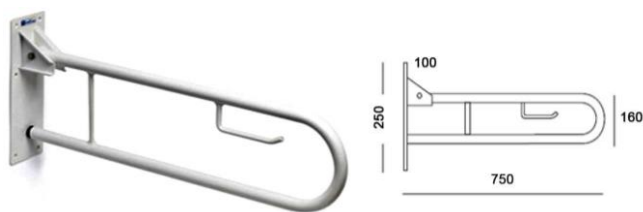

Barra abatible con portarrollos acabado en blanco. Tubo de 32 mm.

Folding bar with toilet roll holder. White finisher. 32 mm pipe.

REF.	€	Caja
501001001	-	1

## BARRA ABATIBLE

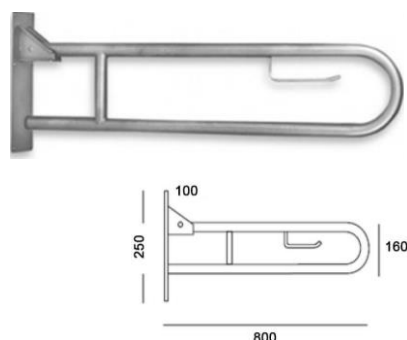

Barra abatible con portarrollos acabado en satinado. Tubo de 32 mm-

Folding bar with toilet roll holder. Satin finisher. 32 mm pipe.

REF.	€	Caja
501002001	-	1

## BARRA SUELO / PARED

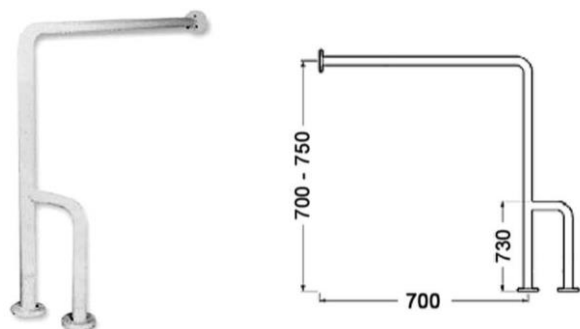

Barra fijación suelo y pared acabado en blanco. Tubo de 32 mm.

Wall to floor grab bar. White finished. 32 mm pipe.

REF.	€	Caja
501003002	-	1

## BARRA SUELO / PARED

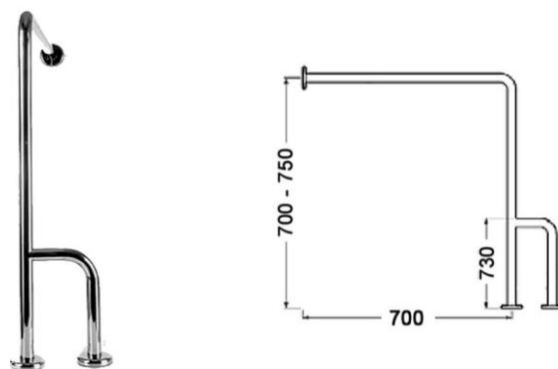

Barra fijación suelo y pared acabado en satinado. Tubo de 32 mm.

Wall to floor grab bar. Satin finished. 32 mm pipe.

REF.	€	Caja
501003003	-	1

## ASIENTO DUCHA ABATIBLE

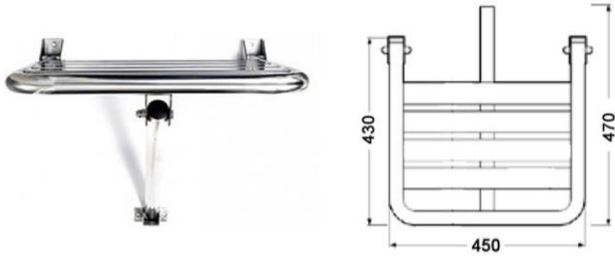

Asiento ducha abatible con soporte acero inoxidable.  
Folding shower seat with support.

REF.	€	Caja
501003004	-	1



## BARRA FIJA BLANCA



Barra fijación pared fija acabado blanco. Tubo de 32 mm.  
Wall fixed grabs bar. White finished. 32 mm pipe.

REF.	Largo	€	Caja
501005001	30 mm	-	1
501005002	40 mm	-	1
501005003	50 mm	-	1
501005004	60 mm	-	1

## BARRA FIJA SATINADA



Barra fijación pared fija acabado satinado. Tubo de 32 mm.  
Wall fixed grabs bar. Satin finished. 32 mm pipe.

REF.	Largo	€	Caja
501004001	30 mm	-	1
501004002	40 mm	-	1
501004003	50 mm	-	1
501004004	60 mm	-	1





# ACCESORIOS





HOTEL



KROMER

## ESCOBILLERO SUELO

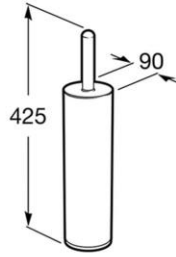

Escobillero suelo acabado acero inoxidable satinado.  
SS toilet brush and holder. Satin finished.

REF.	€	Caja
503001002	-	1

## TOALLERO REPISA

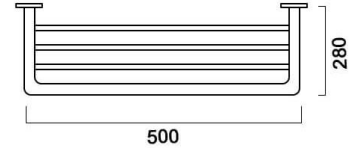

Toallero repisa acero inoxidable acabado cromo.  
SS towel shelf chrome finished.

REF.	€	Caja
503007005	-	1

## BARRA APOYO CON JABONERA

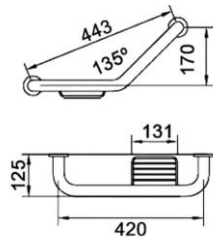

Barra apoyo con jabonera acero inoxidable. Acabado cromo.  
SS wall grab bar with soap dish. Chrome finished.

REF.	€	Caja
503001003	-	1

## ESPEJO AUMENTO REGULABLE

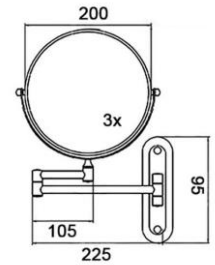

Espejo aumento regulable.  
Adjustable magnifying mirror.

REF.	€	Caja
503002001	-	1



## JABONERA SIMPLE

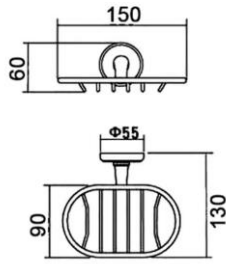

Jabonera simple acabado acero inoxidable cromo.  
SS soap holder. chrome finished.

REF.	€	Caja
503003001	-	1

## PAPELERA PEDAL

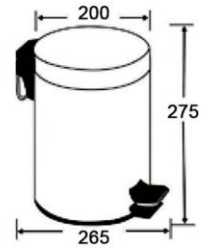

Papelera de pedal con capacidad para 5 litros.  
Pedal operated bin with 5 L.

REF.	€	Caja
503004001	-	1

## PERCHA DOBLE

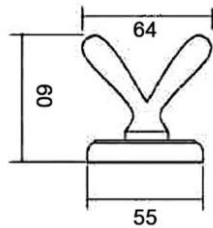

Percha doble.  
Double hook.

REF.	€	Caja
503005001	-	1

## PORTARROLLO PAPEL

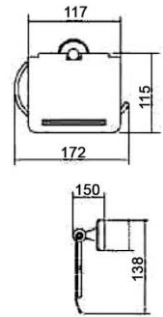

Portarrollos papel higiénico.  
Toilet roll holder.

REF.	€	Caja
503006001	-	1

## RESERVA PORTARROLLOS

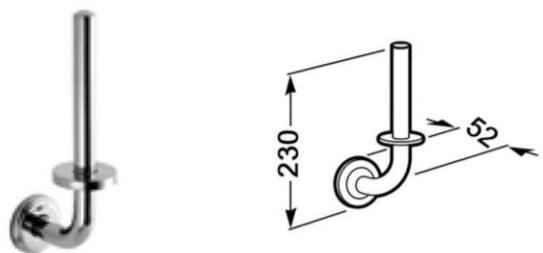

Portarrollo reserva.  
SS spare toilet roll holder.

REF.	€	Caja
503006002	-	1

## TOALLERO ANILLA

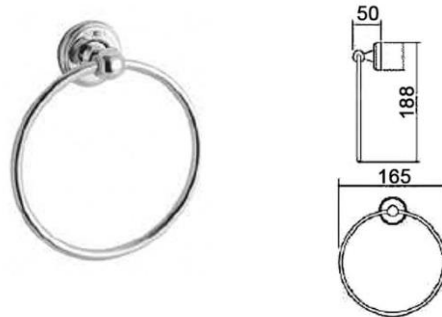

Toallero anilla 25 x 1 mm.  
Ring towel holder 25 x 1 mm.

REF.	€	Caja
503007001	-	1

## TOALLERO BARRA

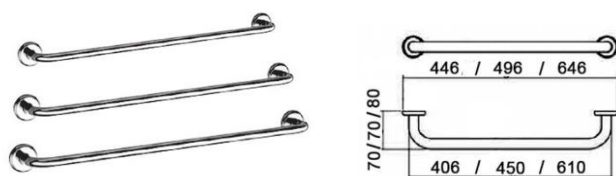

Toallero barra. Tubo de 25 mm.  
Towel rail. 25 mm pipe.

REF.	Largo	€	Caja
503007002	30 cm	-	1
503007003	45 cm	-	1
503007004	60 cm	-	1





# REPUESTOS Y COMPLEMENTOS

## AIREADORES



Aireador.  
Aerator.

REF.	Modelo	€	Caja
301001001	H 22	-	10
301001002	M 20	-	10
301001003	M 24	-	10

## CARTUCHO TEMPORIZADO



Cartucho temporizado.  
Timer cartridge.

REF.	€	Caja
301002002	-	1

## MONTURA CERÁMICA



Montura cerámica.  
Ceramic mounting.

REF.	€	Caja
302004007	-	1

## PISTON FLUXÓMETRO



Pistón para accionamiento de pedal.  
Piston for pedal drive.

REF.	Modelo	€	Caja
301002005	Pedal 1 agua	-	1
301002006	Pedal 2 aguas	-	1
301002007	Pedal mezclad.	-	1

## CARTUCHO CERÁMICO



Cartucho cerámico.  
Ceramic cartridge.

REF.	Medida	€	Caja
301002004	25 mm	-	10
301002003	35 mm	-	10
301002001	40 mm	-	10

## CARTUCHO TERMOSTÁTICO



Cartucho termostático.  
Thermostatic cartridge.

REF.	€	Caja
302003001	-	1

## INVERSOR BAÑO



Inversor de baño.  
Bath inverter.

REF.	Modelo	€	Caja
302001001	KALUS	-	1
302002001	KANIA / KELENA	-	1
302003002	KARES	-	1

302004001	KASTILA L.V.	-	1
302004002	KASTILA CR.	-	1
302008009	KUBER	-	1
302006002	KIRIA	-	1
302008001	KITIANA	-	1

## MANETA KALUS



Maneta para cartucho 40 mm.  
Handle to 40 mm cartridge.

REF.	€	Caja
302001004	-	1

## MANETA KALUS



Maneta para cartucho 35 mm.  
Handle to 35 mm cartridge.

REF.	€	Caja
302001006	-	1

## MANETA KANIA



Maneta para cartucho 35 mm.  
Handle to 35 mm cartridge.

REF.	€	Caja
302002002	-	1

## MANETA KELENA



Maneta para cartucho 35 mm.  
Handle to 35 mm cartridge.

REF.	€	Caja
302005002	-	1

## MANETA KIRIA



Maneta para cartucho 35 mm.  
Handle to 35 mm cartridge.

REF.	€	Caja
302006007	-	1

## MANETA KIRIA PLUS



Maneta para cartucho 35 mm.  
Handle to 35 mm cartridge.

REF.	€	Caja
302007004	-	1

## MANETA KARES



Maneta para cartucho 35 mm.  
Handle to 35 mm cartridge.

REF.	€	Caja
302003004	-	1

## MANETA KITIANA



Maneta para cartucho 35 mm.  
Handle to 35 mm cartridge.

REF.	€	Caja
302008005	-	1

## MANETA KUBER



Maneta para cartucho 35 mm.  
Handle to 35 mm cartridge.

REF.	€	Caja
302004008	-	1

## MANETA KASTILA CROMO



Maneta para montura cerámica.  
Handle to ceramic cartridge.

REF.	€	Caja
302004003	-	1

## MANETA KASTILA LATON VIEJO



Maneta para montura cerámica.  
Handle to ceramic cartridge.

REF.	€	Caja
302004004	-	1

## CONJUNTO HIG. EKO



Conjunto higiénico adaptable a la misma conexión de la cisterna.  
Hygienic shower adaptable to the same cistern connection.

REF.	€	Caja
301009100	-	10

## MANGO EXTRAIBLE KIMERA



Mango 2 posiciones para kimera extraíble.  
2 position handle to removable kimera.

REF.	€	Caja
302004008	-	1

## MANGO EXTRAIBLE KINDU



Mango 2 posiciones para kindu extraíble.  
2 position handle to removable kindu.

REF.	€	Caja
302006011	-	1

## MANGO FREGAD. INDUSTRIAL



Mango para fregadero industrial.  
Handle to profesional mixer single level.

REF.	€	Caja
302006012	-	1

## MANGO CONJ. HIG. EKO



Mango para conjunto higiénico eko.  
Hygienic handle shower.

REF.	€	Caja
301008001	-	1



## FLEXO FREGADERO EXTRAIBLE



Flexo para mango extraible. 1,50 m.  
Hose to removable handle. 1,50 m.

REF.	€	Caja
301005006	-	10

## FLEXO KIT BAÑO

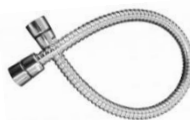

Flexo 50 cm.  
Hose 50 cm.

REF.	€	Caja
301005007	-	10

## FLEXO ESPECIAL CONJ. EKO



Flexo 100 cm.  
Hose 100 cm.

REF.	€	Caja
301005008	-	10

## CONJUNTO LATIGUILLOS



Conjunto 2 latiguillos conexión grifería 40 cm. Pack 40 cm 2 hose to connect with tap.

REF.	€	Pack
301007001	-	2 uds

## JUEGO FIJACIÓN GRIFERIA



Tornillo fijación para grifería.  
Screw to fix tap.

REF.	€	Caja
301004001	-	10

## JUEGO FIJACIÓN GRIFERÍA



Tornillo fijación para grifería.  
Screw to fix tap.

REF.	€	Caja
301004002	-	10

## ESPIGUILLA GRIFO



Espiguilla para la cadena del tapón.  
Plastic support for faucet chain.

REF.	€	Caja
302003007	-	1

## JUEGO EXCENTRICAS KALUS



Entrada M1/2". Salida M3/4".  
Input M1/2 output M3/4.

REF.	MODELO	€	Caja
302001002	Plafón 64 mm Excéntrica 1 cm	-	10
302001003	Plafón 90 mm Excéntrica 2,5 cm	-	10

## JUEGO EXCENTRICAS KUBER



Entrada M1/2". Salida M3/4".  
Input M1/2 output M3/4.

REF.	€	Caja
302003003	-	10

## JUEGO EXCENTRICAS KIRIA



Entrada M1/2". Salida M3/4".  
Input M1/2 output M3/4.

REF.	€	Caja
302006003	-	10

## INVERSOR PARA KIT DUCHA



Inversor para kit de ducha.  
Shower set inverter.

REF.	MEDIDA	€	Caja
301006002	3/4 3/4 1/2	-	1
301006003	3/4 1/2 1/2	-	1
301006004	1/2 1/2 1/2	-	1

## INVERSOR PAR KIT DUCHA



Inversor para kit de ducha doble  
con soporte. 3/4 1/2 1/2  
Shower set double inverter with  
support. 3/4 1/2 1/2

REF.	€	Caja
301006006	-	1

## SIFÓN BOTELLA METÁLICO



Sifón botella metálico cromo.  
Metallic bottle sifon. Chrome finished.

REF.	€	Caja
301008003	-	10

## SIFÓN BOTELLA METÁLICO



Sifón botella metálico negro.  
Metallic bottle sifon. Black finished.

REF.	€	Caja
301008004	-	10

## SIFÓN BOTELLA METÁLICO



Sifón botella metálico blanco.  
Metallic bottle sifon. White finished.

REF.	€	Caja
301008002	-	10

## VÁLVULA CLIC CLAC VARILLA



Válvula clic clac con varilla.  
Click clac valve with stick.

REF.	€	Caja
301003006	-	10

## VALVULA CLIC CLAC CROMO



Válvula clic clac tapón grande.  
Clic clac valve big plug.



REF.	€	Caja
301003003	-	1

## VALVULA CLIC CLAC CROMO



Válvula clic clac tapón pequeño.  
Clic clac valve small plug.



REF.	€	Caja
301003005	-	1

## VALVULA CLIC CLAC NEGRO



Válvula clic clac tapón grande.  
Clic clac valve big plug.

REF.	€	Caja
301003004	-	1

## VALVULA CLIC CLAC LATON V.



Válvula clic clac tapón pequeño.  
Clic clac valve small plug.

REF.	€	Caja
301003002	-	10

## VALVULA CLIC CLAC BLANCA



Válvula clic clac tapón grande  
porcelana. Clic clac valve porcelain  
big plug.

REF.	€	Caja
301003001	-	1



## EXPOSITORES SOBREMESA



REF.	€	Caja
999000001	-	1

## EXPOSITORES SOBREMESA II



REF.	€	Caja
999000002	-	1

## VINILOS Y PLACAS DE PARED





# CONDICIONES GENERALES DE VENTAS

## TERMS AND CONDITIONS OF SALE

Al formalizar un pedido, el cliente acepta, sin reservas, las siguientes condiciones generales de ventas/ todas las condiciones de venta que se detallan a continuación.

By placing an order with KROMER the customer fully agrees to be bound by the following applicable Terms and Conditions of Sale:

### PRECIOS / PRICES

Los precios de esta tarifa pueden ser alterados sin previo aviso. Los precios no incluyen impuestos.

Prices displayed are subject to change without prior notice. All prices stated are exclusive of taxes.

### CONDICIONES DE ENTREGA / DELIVERY

Los plazos de entrega dados serán siempre a modo de información. El no cumplimiento de los plazos de entrega no será objeto de ningún tipo de reclamación o indemnización.

The stated delivery times are always for information purposes only and not binding. Under no circumstances will the company accept any claims or financial demands from the customer for late delivery.

Portes pagados en la Península a partir de 250,00€

Portes pagados a Canarias, Baleares, Ceuta y Melilla a partir de 800,00€

Si la compra es inferior a estas cantidades, los portes serán a cargo del Cliente.

Free shipping on orders from €250.00 valid for mainland Spain.

Free shipping on orders from €800,00 valid for Canary and Balearic Islands, Ceuta and Melilla.

The customer will cover the shipping costs for orders under the amounts stated above.

Toda mercancía entregada será propiedad de KROMER hasta que no se acredite el pago de la misma.

All delivered goods shall remain the property of KROMER until payment has been received in full.

### GARANTIA / WARRANTY

KROMER da cinco años de garantía para grifería con acabados cromados y dos años de garantía para el resto de acabados.

Kromer offers a 5-year warranty for chrome finish taps and a 2-year warranty for all the other finishes.

Nuestra garantía cubre únicamente la reposición del material sin cargo alguno y sin que, en ningún caso, podamos hacernos responsables de los daños y perjuicios que por su defecto hayan podido producirse, directa o indirectamente. No son tampoco objeto de garantía aquellas piezas sujetas a un mal uso o que hayan sido limpiadas con productos abrasivos.

Our warranty only covers the replacement, at no cost to the customer. KROMER shall not in any event be liable for any damages arisen directly or indirectly from faulty items. Our warranty also does not cover parts subject to misuse, or those cleaned using abrasive products.

Estas obligaciones que da esta garantía están sujetas a la presentación de la factura de compra y a la tarjeta de garantía que acompaña cada producto. Para que esta garantía sea válida es necesario la aceptación del defecto por nuestro departamento de Calidad.

All warranty claims are subject to the submission of the purchase invoice and the warranty card accompanying each product. The validity of this warranty requires necessarily the acceptance of the faulty product by our Quality Department

### DEVOLUCIONES / RETURNS

No se admite ninguna devolución sin consulta previa.

No return will be accepted without prior consultation.

En caso de autorización se penalizará con un porcentaje del 15% en concepto de recepción, manipulación, prueba del producto y gastos de envío. El envío siempre será a portes pagados por parte del cliente. No se admitirá ningún material que esté descatalogado.

If authorised, the return will be subject to a restocking fee of 15% covering reception, handling, testing and shipping costs of the product.

Returns must always be sent to us carriage paid by the customer. No discontinued product will be accepted.

No se admitirán reclamaciones pasados siete días desde la recepción de la mercancía.

Any complaints must be made within 7 days from delivery. Beyond that date, no complaints will be accepted.

### JURISDICCIÓN / JURISDICTION

En caso de litigio, ambas partes aceptan someter sus diferencias en los juzgados y tribunales de Algeciras (Cádiz).

Both parties agree to submit to the exclusive jurisdiction of the Courts of the town of Algeciras (Cádiz) to settle any dispute which may arise out of or in connection with these Terms and Conditions, expressly waiving any other jurisdiction.



**KROMER**

DISTRIBUIDORA DE PRODUCTOS SANITARIOS

KROMER DISTRIBUIDORA DE PRODUCTOS SANITARIOS, S.L.

Dirección fiscal:

Avda. de la Guardia Civil, S/N, Blq. 2, Puerta 1D, Edif. Feria, 11204 Algeciras (Cádiz)

Almacén:

Calle Sindicalista Luis Cobos, 23 11203 Algeciras (Cádiz)

[info@kromer.es](mailto:info@kromer.es)

[ventas@kromer.es](mailto:ventas@kromer.es)

628 756 803

[www.kromer.es](http://www.kromer.es)